

User Manual

Vacuklav[®] 41 B+ *Evolution* Vacuklav[®] 43 B+ *Evolution*

Steam sterilizer

from software version 3.240



EN

Dear customer,

We thank you for your confidence demonstrated by the purchase of this MELAG product. As an owner-run and operated family concern founded in 1951, we have a long history of successful specialization in hygiene products for practice-based use. Our focus on innovation, quality and the highest standards of operational reliability has established MELAG as the world's leading manufacturer in the instrument reprocessing and hygiene field.

You, our customer are justified in your demand for the best products, quality and reliability. Providing “**competence in hygiene**” and “**Quality – made in Germany**”, we guarantee that these demands will be met. Our certified quality management system is subject to close monitoring: one instrument to this end is our annual multi-day audit conducted in accordance with EN ISO 13485. This guarantees that all MELAG products are manufactured and tested in accordance with strict quality criteria.

The MELAG management and team.

CE 0197

Contents

1 General guidelines	5
Symbols used	5
Formatting rules	5
MELAconnect App	5
Disposal	5
2 Safety	7
3 Performance specifications	9
Intended use	9
Sterilization procedure	9
Type of the feed water supply	9
Safety equipment	9
Performance characteristics of sterilization programs (type B)	10
Program sequences	11
4 Description of the device	12
Scope of delivery	12
Views of the device	13
Service hatch	14
Symbols on the device	14
Load mounts	15
Energy-saving key	15
Colour touch display	16
LED status bar	18
5 First steps	19
Setup and installation	19
Feed water supply	19
Switching on the steam sterilizer	20
Opening and closing the door	20
6 Loading the steam sterilizer	23
Preparing the load	23
Loading the steam sterilizer	24
7 Sterilization	26
Important information for routine operation	26
Selecting the program	27
Additional program options	28
Starting the program	29
Program run	30
Manual program abort	31
Program end	33
Removing the sterile material	34
Storing sterile material	35
8 Logging	36
Batch documentation	36
Output media	36



Outputting text logs automatically after program end (immediate output)	38
Subsequent log output	39
Finding logs	42
9 Function tests	44
Vacuum test	44
Bowie & Dick test	44
10 Settings	46
Logging	46
User administration	52
Formatting the CF card	55
Additional drying	56
Intelligent drying	56
Water supply	57
Date and time	58
Brightness	58
Volume	59
View	59
MELAconnect	61
Key tone	61
Screensaver	62
Log printer MELAprint 42/44	63
Label printer MELAprint 60	63
Sensitivity	63
Energy-saving mode	63
11 Maintenance	65
Servicing intervals	65
Cleaning	65
Avoiding staining	68
Checking and oiling the door lock	68
Maintenance	68
12 Pause times	69
Frequency of sterilization	69
Duration of the operating pause	69
Decommissioning	69
Emptying the double jacket	69
Transport	70
Recommissioning after relocation	70
13 Malfunctions	71
Displaying messages in MELAconnect	71
Messages	72
Warning and error messages	72
14 Technical data	83
15 Accessories and spare parts	84
Glossary	86

1 General guidelines

Please read this user manual carefully before commissioning the device. The manual includes important safety instructions. Make sure that you always have access to digital or printed version of the user manual.

Should the manual no longer be legible, is damaged or has been lost, you can download a new copy from MELAG download centre at www.melag.com.

Symbols used

Symbol	Explanation
	Indicates a dangerous situation, which if not avoided, could entail slight to life-threatening injuries.
	Draws your attention to a situation, which if not avoided, could result in damage to the instruments, the practice fittings or the device.
	Draws your attention to important information.

Formatting rules

Example	Explanation
see Chapter 2	Reference to another text section within this document.
Universal- Program	Words or phrases appearing on the display of the device are marked as display text.

MELAconnect App

You can use the MELAconnect app from any location in your practice, to access the device status and program progress of the MELAG devices incorporated in your practice network.

MELAconnect provides the following functions:

- Accessing the device status and program progress
- Accessing the user manuals and video tutorials for using the device
- Locating malfunctions and accessing solutions and assistance immediately
- Performing quick paperless documentation of routine checks of MELAG sealing devices
- Contacting the service technician (contact data must be entered manually)

In order to connect the MELAconnect app with your MELAG device, see the [MELAconnect](#) [▶ page 61] section.

Disposal

MELAG devices are synonymous with high quality and a long life-span. When you eventually need to de-commission your MELAG device, the required disposal of the device can take place with MELAG in Berlin.

Dispose of accessories and consumption media which you no longer require in the appropriate manner. Comply with all relevant disposal specification in terms of possibly contaminated waste.

The packaging protects the device against transport damage. The packaging materials have been selected for their environmentally-friendly disposability and can be recycled. Returning the packaging to the material flow reduces the amount of waste and saves raw materials.

Dispose of spare parts that are no longer used, e.g. seals, properly.

MELAG draws the operator's attention to the fact that they are responsible for deleting personal data on the device to be disposed of.

MELAG draws the operator's attention to the fact that they may be legally obliged (e.g. in Germany according to ElektroG) to remove used batteries and accumulators non-destructively before handing over the device, provided they are not enclosed in the device.

2 Safety



When operating the device, comply with the following safety instructions as well as those contained in subsequent chapters. Use the device only for the purpose specified in these instructions. Failure to comply with the safety instructions can result in injury and/or damage to the device.

Qualified personnel

- As with the preceding instrument reprocessing, only competent personnel should undertake sterilization using this steam sterilizer.
- The operator must ensure that the users have been trained in the operation and safe handling of the device.
- The operator must ensure that the users are regularly trained in the operation and safe handling of the device.

Setup, installation and commissioning

- Check the device after unpacking for any damage suffered during transport.
- The device should only be setup, installed and commissioned by MELAG authorised persons.
- The connections for electrical provision and water supply and discharge must be setup by trained personnel.
- Using the optional electronic leak detector (water stop) minimises the risk of water damage.
- The device is not suitable for operation in explosive atmospheres.
- Install and operate the device in a frost-free environment.
- The device is conceived for use outside the patient area. The device should be located a minimum of 1.5 m radius away from the treatment area.
- The documentation media (computer, CF card reader etc.) must be placed in such a way that they cannot come into contact with liquids.
- Observe all the information contained in the technical manual during commissioning.

Power cable and power plug

- Only the power cable included in the scope of delivery may be connected to the device.
- The power cable may not be replaced by a cable determined to be insufficient.
- Comply with all legal requirements and locally-specified connection conditions.
- Never operate the device if the plug or power cable are damaged.
- The power cable or plug should only be replaced by authorised technicians.
- Never damage or alter the power plug or cable.
- Never unplug by pulling on the power cable. Always take a grip on the plug.
- Ensure that the power cable does not become jammed in.
- Never lead the cable along a source of heat.
- Never fix the power cable with sharp objects.

Spring safety valve

- The free movement of the valve rod must be guaranteed. For example, the spring safety valve must not be taped or blocked. Install the device in such a way that the proper functioning of the spring safety valve is guaranteed.

Reprocessing and sterilization

- Follow the manufacturer's instructions of your textile articles and instruments regarding their reprocessing and sterilization.

- Comply with the relevant standards and directives applicable to the reprocessing and sterilization of textiles and instruments (in Germany e.g. from the RKI and DGSV).
- Only ever use packaging material and systems which have been cleared by their manufacturer for steam sterilization.

Program abort

- Please observe that depending on the time of the program abort, opening the door following a program abort can lead to hot steam leaving the sterilization chamber.
- Depending on the time of the program abort, it is possible that the load is unsterile. Observe the clear instructions shown on the display of the device. Sterilize the affected load after re-wrapping again.

Removing the sterile material

- Never use force to open the door.
- Use a tray lifter to remove the tray. Never touch the sterilized equipment, the chamber, the mount or the inside of the door with bare hands. The components are hot.
- Check the packaging on the sterile material for damage when removing it from the steam sterilizer. Should the packaging be damaged, re-pack the load and re-sterilize it.

Transport and storage

- Store and transport the device in a frost-free environment.
- The device should always be carried by two people.
- Use suitable carrying straps to carry the device.

Maintenance

- Maintenance should only be performed by authorised technicians.
- Maintain the specified servicing intervals.
- Only original MELAG spare parts may be used.

Repair

- Never open the device housing. Incorrect opening and repair can compromise electrical safety and pose a danger to the user. The device may only be opened by an authorised technician who must be a qualified electrician.

Malfunctions

- Should the device issue the same malfunction message repeatedly, turn off the device and if necessary, inform your stockist.
- The device may only be serviced by authorised technicians.

Notification requirement in the event of serious accidents in the European Economic Area

- Please note that all serious accidents which occur in connection with the medical product (e.g. death or serious deterioration in the state of health of a patient) which were presumably caused by the product, must be reported to the manufacturer (MELAG) and the relevant authority of the member state, in which the user and/or patient resides.

3 Performance specifications

Intended use

This steam sterilizer is designed for application in a medical context, e.g. general practitioners and dental practices. According to EN 13060, this steam sterilizer is considered as a steam sterilizer with type B cycles. As a universal steam sterilizer, it is suited to highly-demanding sterilization tasks. It can be used for a range of tasks such as the sterilization of large quantities of instruments with narrow lumen and transmission instruments - both wrapped or unwrapped - and of textiles.



WARNING

Any attempt to sterilize liquids can result in a delay in boiling. This can result in burns and damage to the device.

- Never use this device to sterilize fluids. It is not licensed for the sterilization of fluids.

Sterilization procedure

The steam sterilizer sterilizes on the basis of the fractionated vacuum procedure. This guarantees the complete and effective wetting/penetration of the load with saturated steam.

This procedure enables the sterilization of loads common to a doctor's practice.

The steam sterilizer uses the double jacket technology to generate the sterilization steam, i.e. the steam sterilizer is fitted with a separate steam generator combined with a double-walled sterilization chamber. After heating, steam is held constantly available in the double jacket. This gives the walls of the sterilization chamber a defined temperature and protects the sterilization chamber from overheating. This especially effective procedure supports the quick evacuation of the air from the sterilization chamber, the sterilization packaging and instrument cavities. This permits the sterilization of large quantities of instruments or textiles directly one after each other, thereby achieving excellent drying results.

Type of the feed water supply

The steam sterilizer works with a one-way feed water system. This means that it uses fresh feed water (demineralized or distilled water) for every sterilization procedure. The quality of the feed water is subject to permanent monitoring via integrated conductivity measurement. If combined with careful preparation of the instruments, this serves largely to prevent stain accretion on the instruments and soiling of the steam sterilizer.

Safety equipment

Internal process monitoring

A process evaluation system is integrated in the electronics of the steam sterilizer. It compares the process parameters (such as temperature, time and pressure) during a program run. It monitors the parameters in terms of their threshold values during control and regulation and guarantees safe and successful sterilization. A monitoring system checks the device components of the steam sterilizer for their functionality and interplay. If one or more parameters exceeds pre-determined threshold values, the steam sterilizer issues warning or fault messages and if necessary, aborts the program. In the case of a program abort, follow the instructions on the display.

The steam sterilizer uses an electronic parameter control. This enables the steam sterilizer to optimise the total operating time of a program in dependence on the load.

Door mechanism

The steam sterilizer constantly checks pressure and temperature in the sterilization chamber and prevents the door from being opened when over-pressure has built up in the chamber. The motor-driven automatic door locking mechanism opens the door slowly by turning the locking spindle. This also holds the door

whilst it opens. Pressure compensation will have been performed by the time that the door is completely open, even following pressure differences.

Quantity and quality of the feed water

The quantity and quality of the feed water is automatically checked before every program start.

Performance characteristics of sterilization programs (type B)

The results in this table show which inspections were performed on the steam sterilizer. The marked field shows compliance with all the applicable sections of the standard EN 13060.

Type tests	Universal-Program	Quick-Program B	Quick-Program S	Gentle-Program	Prion-Program
Program type in accordance with EN 13060	Type B	Type B	Type S	Type B	Type B
Dynamic pressure test of the sterilization chamber	X	X	X	X	X
Air leakage	X	X	X	X	X
Empty chamber test	X	X	X	X	X
Solid load	X	X	X	X	X
Porous partial load	X	--	--	X	X
Porous full load	X	--	--	X	X
Simple hollow body	X	X	X	X	X
Product with narrow lumen	X	X	--	X	X
Single wrapping	X	X	--	X	X
Multiple wrapping	X	--	--	X	X
Drying solid load	X	X	X	X	X
Drying, porous load	X	--	--	X	X
Sterilization temperature	134 °C	134 °C	134 °C	121 °C	134 °C
Sterilization pressure	2.1 bar	2.1 bar	2.1 bar	1.1 bar	2.1 bar
Sterilization time	5:30 min	5:30 min	3:30 min	20:30 min	20:30 min
X = Complies with all applicable sections of the standard EN 13060					

Program sequences

A program runs in three main phases: the air removal and heating up phase, the sterilization phase and the drying phase. After program start, you can follow the program run on the display. It shows the chamber temperature and pressure as well as the time until the end of sterilization / drying.

Program phases of a standard sterilization program

Program phase	Description
1. Air removal and heating up phase	<p>Air removal</p> <p>The air removal phase comprises of the conditioning and the fractionating phase. During conditioning, steam is repeatedly injected into and removed from the sterilization chamber. This generates over-pressure and the residual air is removed. Then, during fractionation, the mixture of air and steam is evacuated from the sterilization chamber and steam is injected. This procedure is also called the fractionated vacuum procedure.</p>
	<p>Heating</p> <p>The continued steam injection into the sterilization chamber leads to an increase in pressure and temperature which continues until the program-specific sterilization parameters have been reached.</p>
2. Sterilization phase	<p>Sterilizing</p> <p>If the pressure and temperature correspond to the program-dependent nominal values, the sterilization phase begins. The corresponding process parameters (pressure and temperature) are held at sterilization level. The sterilization time (holding time) is indicated on the display.</p>
3. Drying phase	<p>Pressure release</p> <p>The sterilization phase is followed by pressure release from the sterilization chamber.</p>
	<p>Drying</p> <p>The sterile material is dried using a vacuum (vacuum drying).</p>
	<p>Ventilation</p> <p>Upon program end, the sterilization chamber is filled with sterile air via the air filter and adjusted to the ambient pressure. A corresponding display message Ventilation is shown.</p>

Program phases of the vacuum test

Program phase	Description
1. Evacuation phase	The sterilization chamber is evacuated until the pressure for the vacuum test has been reached.
2. Equilibration time	An equilibration time of 5 min will follow.
3. Measurement time	The measuring time is 10 min. The pressure increase within the sterilization chamber is measured during the measurement time. The evacuation pressure and the equilibration time or measurement time are shown on the display.
4. Ventilation	The chamber is ventilated after the end of the measuring time.
5. Test end	The display shows the test result, the batch number, the total number of batches and the leakage rate.

4 Description of the device

Scope of delivery

Please check the scope of delivery before setting up and connecting the device.

Standard scope of delivery

- Vacuklav 41 B+ or Vacuklav 43 B+
- User manual
- User Manual Accessories for small steam sterilizers
- Manufacturer's inspection report and declaration of conformity
- Warranty certificate
- Technical manual
- Record of installation and setup
- Tray lifter
- Power cable
- 4x cover caps for niches for mounts in the side wall
- Allen key with which to open the door in an emergency
- hose for emptying the interior water storage tank
- Oil for door lock bushing
- Test gauge TR16 for door lock nut

Views of the device

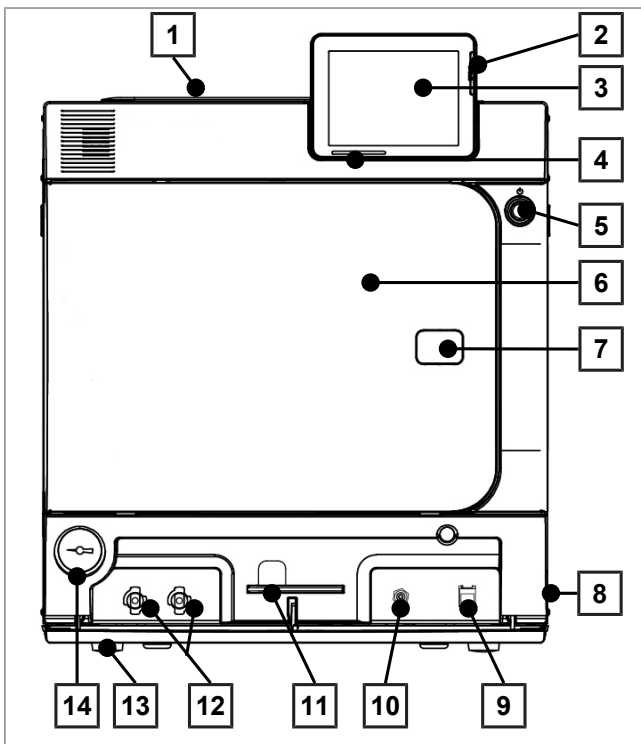

Fig. 1: View from front

- 1 Tank lid of the internal storage tank
- 2 CF card slot
- 3 Colour touch display
- 4 LED status bar
- 5 Energy-saving key
- 6 Door (swings open to the left)
- 7 Opening for door opening in an emergency^{*)}
- 8 Power switch (covered, accessible from the side)
- 9 Ethernet connection
- 10 Overheat control reset button
- 11 Allen key 5 mm to open the door in an emergency
- 12 Quick coupling for emptying the storage tank
- 13 Front device foot (adjustable)
- 14 Manometer for pressure display on the double-jacket steam generator

^{*)} behind cover

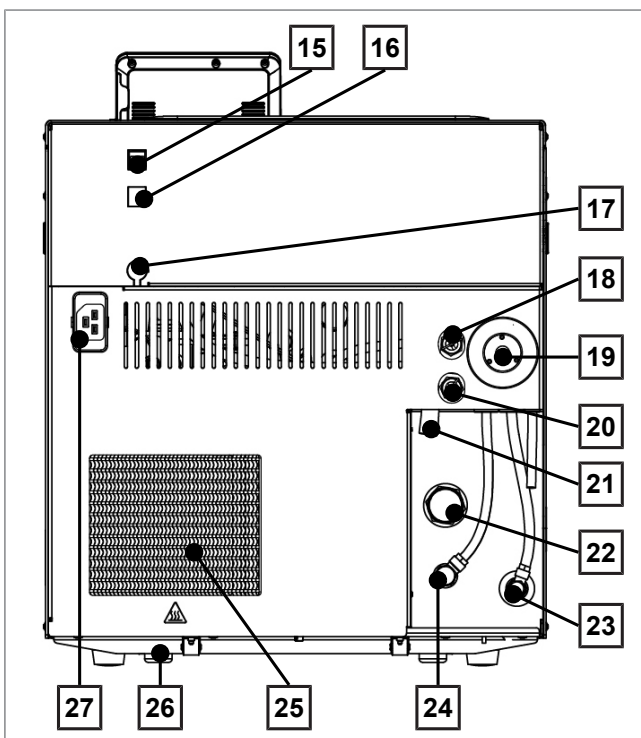
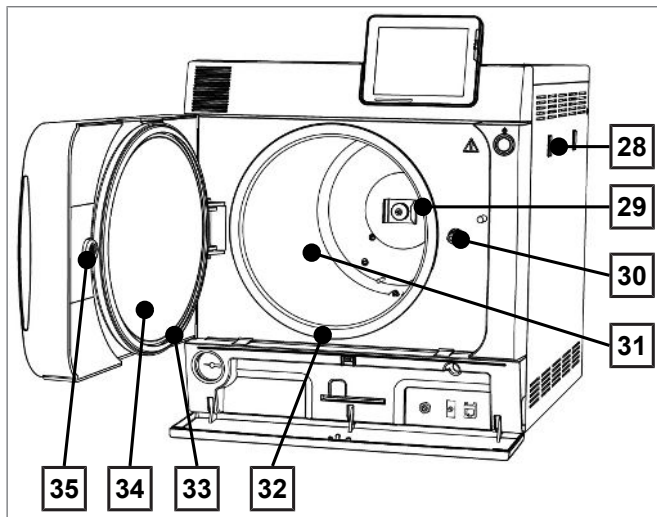

Fig. 2: View from rear

- 15 Ethernet connection
- 16 Ethernet connection, optional (upgradeable)
- 17 Optional connection of a Flex display
- 18 Spring safety valve chamber
- 19 Sterile filter
- 20 Spring safety valve double jacket
- 21 Emergency overflow
- 22 One-way outlet
- 23 Feed water inflow (swivel screw connection for Ø8x1 hose, alternative straight)
- 24 Connection pressure release
- 25 Cooler
- 26 Rear device foot (fixed)
- 27 Power cable connection



- 28 Mount for the water treatment unit MELAdem
- 29 Spring clip for fixing the mount "Plus"
- 30 Door spindle
- 31 Sterilization chamber
- 32 Chamber sealing face
- 33 Door seal
- 34 Round blank
- 35 Bushing

Fig. 3: View from front, door open

Service hatch

The service hatch is opened by pressing on the recess. The service hatch is closed again by closing and pressing on the recess.

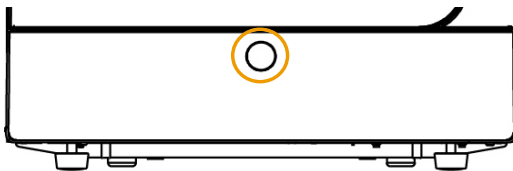

Fig. 4: Opening and closing the service hatch

Symbols on the device



Manufacturer of the medical device



Date of manufacture of the medical device



Identifies a medical device



Medical device serial number from the manufacturer



Article number of the medical device



Information about the chamber volume



Operating temperature of the device



Operating pressure of the device



Electrical connection of the device: AC current



Read this user manual carefully before commissioning the device.



In affixing this CE mark, the manufacturer declares that this medical product fulfils the basic requirements of the Medical Device Directive. The four-digit number confirms that this is monitored by an approved certification agency.



In affixing this CE mark, the manufacturer declares that this product fulfils the basic requirements of the Pressure Equipment Directive. The four-digit number confirms that this is monitored by an approved certification agency.



The device may not be disposed as domestic waste. The vendor is responsible for appropriate disposal of the device - it must be delivered to the vendor to be disposed of. MELAG devices are synonymous for long-term quality. When you eventually need to decommission your MELAG device, we offer a special disposal service. Simply contact your stockist.



Draws your attention to a hot surface. Should the fan fail, the cooling unit fins can become hot.

Symbols on the power switch



Switching on device



Switching off device

Load mounts

Detailed information regarding the various mounts, their combinability with various load holders and their application can be found in the document "User Manual Accessories for small steam sterilizers".

A spring clip is located on the rear panel of the sterilization chamber to fix the mount. When using a "Plus" mount, slide the mount into the sterilization chamber to its fullest extent, until the mount snaps into the spring clip.

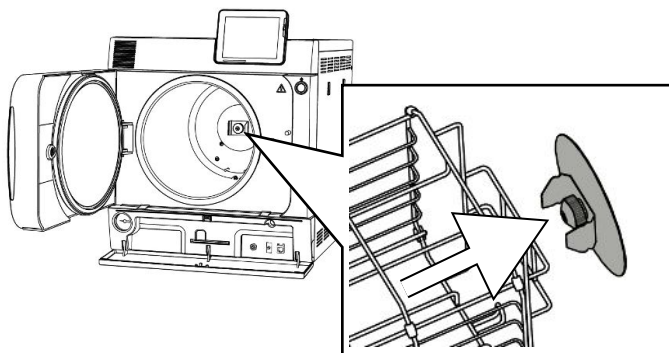

Energy-saving key

Pressing the energy-saving key activates the energy-saving mode and switches off the display. The double jacket will not be heated until the next program start. This corresponds to waiting time 2, see also [Energy-saving mode](#) [▶ page 63].

Pressing the energy-saving key again will switch the display back on.

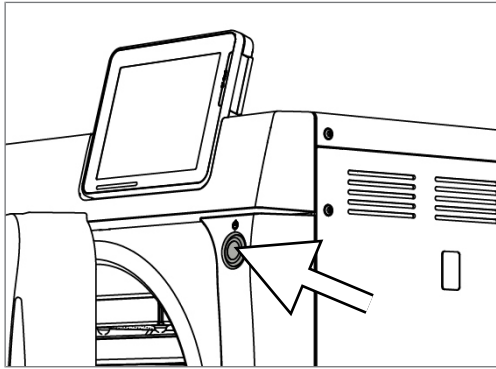

PLEASE NOTE

The energy-saving mode can not be activated during a program run.





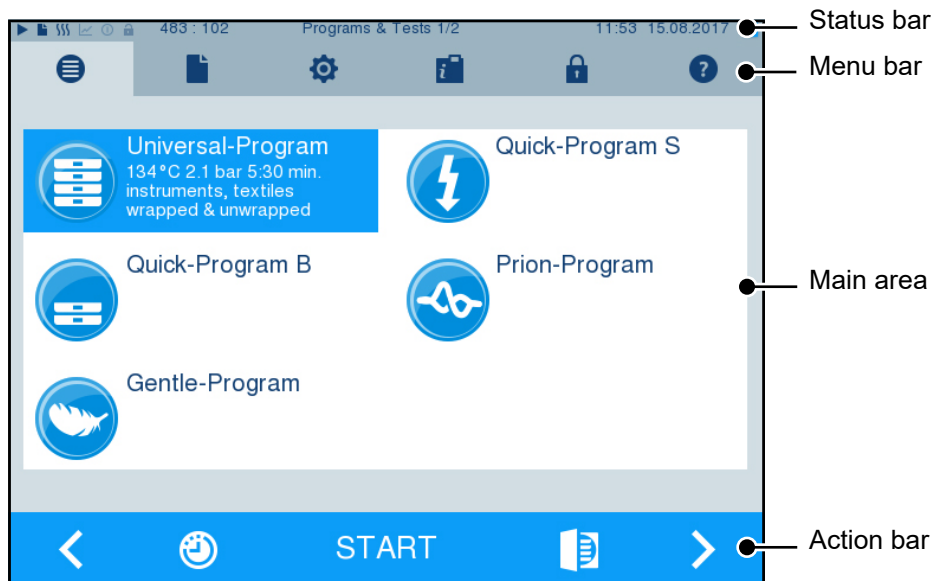

State	Meaning
Lighted	The energy-saving mode can be activated.
Not lighted	The energy-saving mode can not be activated.









Colour touch display

The operating panel consists of a colour 5 inch touch display.



Symbols in the status bar		Meaning
	Program/tests	Indicates whether a program/test is running
	Immediate output	Indicates whether immediate output is activated/deactivated
	Additional drying	Indicates whether additional drying is activated/deactivated
	Graphic logs	Indicates whether the graphic log recording is activated/deactivated
	Energy-saving mode	Indicates whether the steam sterilizer is currently in energy-saving mode
	Service area	Indicates whether a service technician is logged-in to the service area
	CF card status	Indicates whether a CF card has been inserted and whether a reading or writing action is in process

Symbol in the menu bar		Meaning
	Program/tests	Lists all sterilization programmes and tests e.g. Vacuum test, Bowie & Dick test etc.
	Log output	Here you can display the entire log list or the list of logs from a restricted time e.g. the day, month etc. You can also delete specific log types and logs.
	Settings	Here you can perform various settings such as date and time, brightness etc. It also enables one-time setting of the standard logging settings regarding log output.
	Info/status window	Displays information regarding the software version and device data e.g. total number of batches, maintenance counter, log settings, log memory and further technical values.
	Service area	Only for service technicians.
	Help menu	Depending on the window selected and the operating situation, gives information regarding operation or the function of the window currently selected.

Symbols in the action bar		Meaning
	Door open	Opens the door of the steam sterilizer
	Back	Navigates to the previous window
	Forwards	Navigates to the next window
	Cancel / return without saving	Navigates to the superordinate menu, leaves the window without saving
	Zoom (+)	Displays further details such as further values after a completed program
	Start time pre-selection	Navigates to the menu Start time pre-selection
	Delete	Deletes logs from the internal log memory/deletes the log printer or label printer stored as standard
	Search	Searches for label printer(s)/log printer(s)
	Skip	Navigates to the next window without entry of the required data

LED status bar

The status bar on the lowest edge of the display indicates different situations with various colours.

Colour of the LED	Meaning
Blue	Standby, program running, drying has not yet begun
Green	Drying running, program completed successfully
Yellow	Warning message, software update is running
Red	Malfunction message, program not completed successfully

5 First steps

Setup and installation



PLEASE NOTE

Comply with the specifications of the technical manual during setup and installation. This contains all building-side requirements.

Record of installation and setup

The record of installation and setup is to be completed by the responsible stockist and a copy sent to MELAG as proof of the correct setup, installation and initial commissioning. This is a constituent part of any guarantee claim.

Feed water supply

Steam sterilization requires the use of distilled or demineralized water, known as feed water. Annex C of EN 13060 specifies the guideline values to be observed.

The steam sterilizer requires c. 3 l feed water for the first filling of the steam generator.

The feed water supply is effected either via the internal feed water tank or via a separate water treatment unit (e.g. MELAdem 40 / MELAdem 47). The used feed water, so called waste water is either collected in the internal storage tank on the waste water side (left) and emptied manually or disposed of automatically via a building-side waste water connection.



NOTICE

When connecting an external feed water supply it is necessary to connect an external wastewater outflow as well.

There is a risk that hot wastewater might run through the emergency overflow.

Using the internal water storage tank

Video tutorial

See also "Filling and emptying stand-alone autoclaves".



The internal storage tank holds max. 5 litres. This volume of feed water is sufficient for up to 7 sterilization runs.

1. To fill the storage tank with fresh feed water remove the lid and fill the right-hand chamber of the storage tank with fresh feed water up to the MAX mark.

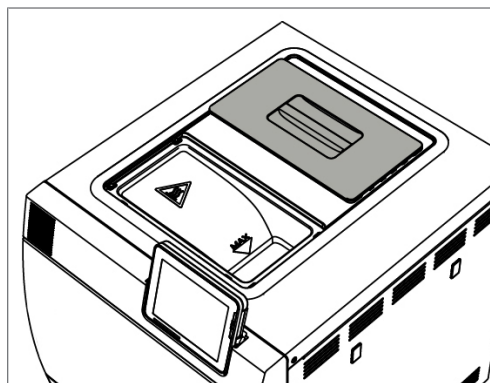

2. Set the feed water supply in the display to **INTERNAL**, see settings, [Water supply](#) [▶ page 57].

Switching on the steam sterilizer

Video tutorial

See also "Operation".



The following must be fulfilled or present:

- ✓ *The steam sterilizer is connected to the electricity supply.*
- ✓ *The feed water supply is secure. The steam sterilizer requires approx. 3 litres feed water for the first filling of the steam generator.*

1. Switch on the steam sterilizer at the power switch.

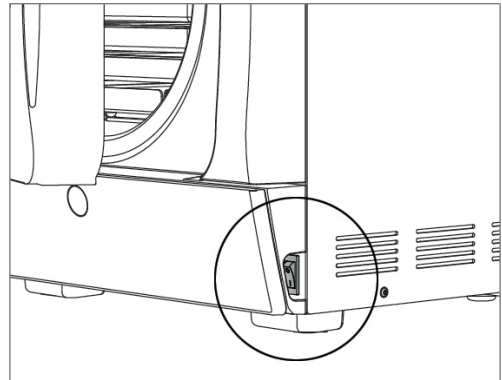

2. When the welcome screen appears, press CONTINUE. The display switches to the main menu.

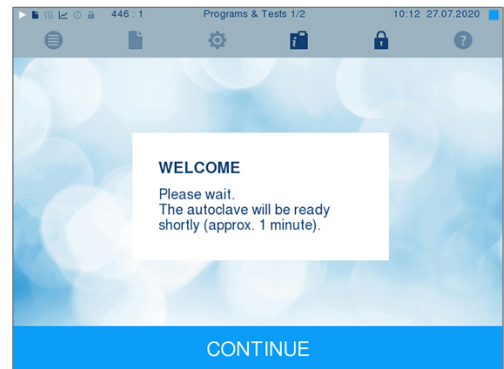

The feed water level is checked and pre-heated immediately after activation.

Depending on the device type, it requires a heat-up time of approx. 9 - 13 min after being switched on. This time is required for the pre-heating of the double-jacket steam generator.

Opening and closing the door

The steam sterilizer is fitted with a motor-driven automatic door locking mechanism with a threaded spindle. Entry on the display is only possible when the door is closed.

Opening the door

The door is opened by pressing on the door symbol  on the display.

When opening the door, comply with the following instructions, so as to ensure faultless operation of the door locking mechanism.

- ▶ Never use force to open the door.
- ▶ Do not pull vigorously at the door to open it. The door opens automatically.
- ▶ Do not place any load on the door, e.g. by leaning on it.



PLEASE NOTE

The door is to be left open only whilst loading and unloading the steam sterilizer. Keeping the door closed saves energy.

Closing the door

To close the door, press it firmly inwards until the automatic door lock engages. After the door has been closed, the display returns to the program menu. The door is locked pressure-tight upon program start.

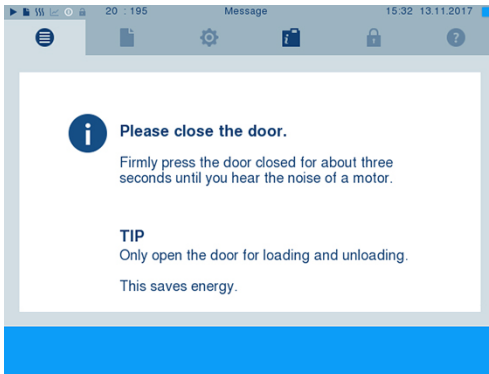

When closing the door, comply with the following instructions to guarantee faultless operation of the door locking mechanism:

- ▶ Never slam the door.
- ▶ Press the door closely to the housing.
- ▶ Hold the door closed for min. 3 s until the door lock engages.

Manual door emergency-opening



CAUTION

Danger of scalding from hot steam.

Hot steam egress from the sterilization chamber is possible e.g. if it is necessary to open the door immediately after the end of a program. This could result in scalding.

- Should steam be issued from the rear of the device after its deactivation, wait until the procedure has finished. Wait a further 5 min before opening the door.
- Stand to one side of the door and maintain sufficient distance.
- Allow the sterilization chamber to cool before removing the load.

In emergency situations e.g. power outage, the door can be opened in the following fashion:

1. If the steam sterilizer is still switched on, switch it off at the power switch (pos. a).

2. Remove the cover cap in order to facilitate emergency door-opening (pos. b) by pushing out (e.g. with a small narrow slotted screwdriver).

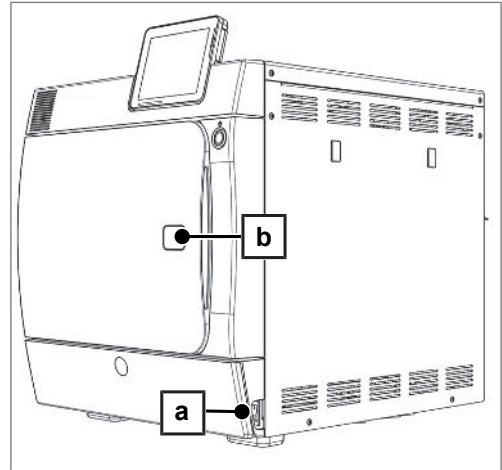

3. Insert the 5 mm Allen key included in the scope of delivery in the opening. The Allen key can be stored in the bracket behind the service hatch intended for this purpose.



4. Turn the Allen key to open the door in a clockwise direction.

**NOTICE**

Do not open the door as long as the Allen key is inserted. This may cause damage to the plastic casing.

5. Remove the Allen key.
6. Open the door and return the cover cap.

6 Loading the steam sterilizer

Preparing the load

Always clean and disinfect properly before sterilization. Only in this way is it possible to guarantee the subsequent sterilization of the load. The materials used, cleaning agents and reprocessing procedure are of decisive significance.

Reprocessing the instruments

Unwrapped sterile material loses its sterility on contact with ambient air. If you intend to store your instruments sterilely, wrap them in suitable packaging before sterilization.

Ensure the following when reprocessing used and brand-new instruments:

- ▶ Observe both the instrument manufacturer's instructions regarding reprocessing and sterilization as well as the relevant standards and directives (in Germany, for example, from RKI, DGSV and DGUV Regulation 1).
- ▶ Clean the instruments exceptionally thoroughly e.g. using an ultrasonic device or washer-disinfector.
- ▶ Rinse the instruments after cleaning and disinfecting, where possible with demineralised or distilled water and then dry the instruments thoroughly with a clean, non-fuzzing cloth.
- ▶ Use only those care agents suitable for steam sterilization. Consult the manufacturer of the care agents. Do not use any water repellent agents or oils impermeable to steam.
- ▶ When using ultrasonic devices, care equipment for handpieces and washer-disinfectors, comply with the manufacturer's reprocessing instructions.



NOTICE

The presence of residual disinfection and cleaning fluids results in corrosion.

This could result in increased maintenance requirements and a restriction of the steam sterilizer function.

Reprocessing textiles



WARNING

The incorrect reprocessing of textiles, e.g. a textile package can prevent steam penetration or produce poor drying results.

The textiles could not be sterilized.

Comply with the following points when reprocessing textiles and putting the textiles in sterilization containers:

- ▶ Comply with both the manufacturer's instructions of the textiles regarding reprocessing and sterilization as well as the relevant standards and directives (in Germany e.g. from the RKI and DGSV).
- ▶ Arrange the folds in the textiles parallel to each other.
- ▶ Stack textiles vertically wherever possible and not too closely together in the sterilization container. This enables the development of flow channels.
- ▶ If textile packages do not remain together, wrap the textiles in sterilization paper.
- ▶ Only ever sterilize dry textiles.
- ▶ The textiles may not be permitted to come into direct contact with the sterilization chamber; otherwise they will become saturated with condensate.

Loading the steam sterilizer

Effective sterilization and good drying is only possible if the steam sterilizer has been loaded correctly.

Ensure the following during loading:

- ▶ Insert trays or sterilization containers in the chamber only with their appropriate mount.

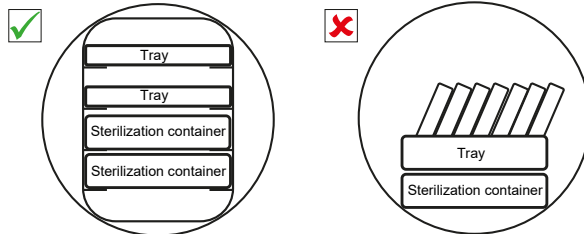

- ▶ Use perforated trays such as those from MELAG. Only in this way can condensate drain off. Non-perforated bases or half-shells for holding the load lead to poor drying results. 
- ▶ The use of paper tray inserts can result in poor drying results.
- ▶ Wherever possible, ensure the separate sterilization of textiles and instruments in separate sterilization containers or sterilization packaging. This leads to better drying results.

Packaging

Only ever use packaging materials and systems (sterile barrier systems) which fulfil the standard EN ISO 11607-1. The correct use of suitable packaging is important in achieving successful sterilization results. You can use re-usable rigid packaging systems or soft packaging such as transparent sterilization packaging, paper bags, sterilization paper, textiles or fleece.

Video tutorial

See also "Loading".



Closed sterilization containers



WARNING

Risk of contamination due to insufficient steam penetration or poor drying.

- Use only suitable sterilization containers.
- Do not cover the perforations when stacking the sterilization containers so that the condensate can drain off.

Please comply with the following when using closed sterilization containers:

- ▶ Use aluminium sterilization containers. Aluminium retains and conducts heat and thus accelerates drying.
- ▶ Closed sterilization containers must be either perforated or have a valve on at least one side. MELAG sterilization containers (e.g. MELAstore Boxes) fulfil the requirements for successful sterilization and drying.
- ▶ Wherever possible, ensure that sterilization containers are only stacked on top of those of identical size, so that the condensate can run down their sides.
- ▶ Ensure that the perforations are not covered when stacking the containers.

Soft sterilization packaging

Soft sterilization packaging can be used in both sterilization containers and on trays. Please comply with the following when using soft sterilization packaging e.g. MELAfol:

- ▶ Arrange soft sterilization packaging in a perpendicular position and at narrow intervals.
- ▶ Place transparent sterilization packages on their edge wherever possible and with the paper side facing downwards.
- ▶ Do not place multiple soft sterilization packages flat on top of each other on a tray or in a container.
- ▶ When loading the steam sterilizer, make sure that either the film or paper sides of different bags are facing each other.
- ▶ If the seam seal tears during sterilization, this could be caused by the choice of undersized packaging. Re-pack the instruments with larger packaging and perform sterilization again.
- ▶ Should the seam seal rip during sterilization, extend the sealing pulse on the sealing device or make a double seam.

Multiple wrapping

The steam sterilizer works with a fractionated vacuum procedure. This permits the use of multiple wrapping.

Mixed loads

Observe the following when sterilizing mixed loads:

- ▶ Always place textiles at the top.
- ▶ Place the sterilization containers at the bottom.
- ▶ Place unwrapped instruments at the bottom.
- ▶ Place the heaviest loads at the bottom.
- ▶ Place transparent sterilization packaging and paper bags at the top - except in combination with textiles. In this case, place them at the bottom.

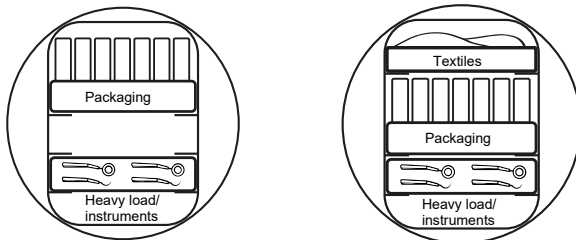

7 Sterilization

Important information for routine operation

Comply with the recommendations issued by the Robert Koch Institute (RKI) and the information contained in DIN 58946-7.

Video tutorial

See also "Routine Checks".



Manufacturer's recommendation for the routine operation of type B steam sterilizers¹⁾

When is it necessary to make checks?	How should the checks be made?
Once per working day	<ul style="list-style-type: none"> ▪ Visual check of the door seal and the door lock for damage ▪ Check the operating media (electricity, feed water and water connection if necessary) ▪ Check the documentation media (printer paper, computer, network) <p>MELAG recommends performing the steam penetration test with MELAcontrol Helix/MELAcontrol Pro in the Universal-Program (test system in accordance with EN 867-5).</p>
Once a week	<ul style="list-style-type: none"> ▪ Vacuum test <p>Tip: In the mornings before starting work – the steam sterilizer must be cold and dry</p>
Batch-related tests	<p>With "Critical B" instruments:</p> <ul style="list-style-type: none"> ▪ MELAcontrol Helix/MELAcontrol Pro must be used as batch control with every sterilization cycle. <p>With "Critical A" instruments:</p> <ul style="list-style-type: none"> ▪ The process indicator (type 5 in accordance with EN ISO 11140) must be used as batch control with every sterilization cycle. <p>With "Critical A + B" instruments:</p> <ul style="list-style-type: none"> ▪ MELAcontrol Helix/MELAcontrol Pro must be used as batch control with every sterilization cycle. <p>This simplifies the working procedure and increases security. You can omit the daily steam penetration test with MELAcontrol Helix/MELAcontrol Pro (see above). The use of another test system in accordance with EN 867-5 is possible. The number of the available test systems means that MELAG is not able to provide technical support when using a different system.</p>



PLEASE NOTE

Document the results of the tests.

- The indicator test strips used need not be stored.

¹⁾in accordance with the current recommendations from the Robert Koch Institute

Selecting the program





Video tutorial

See also "Program selection".







Select the sterilization program according to whether and how the load is packed. You must also consider the temperature resistance of the load. All sterilization and additional programs are displayed in the **Programs & Tests** menu. The following tables show you which program you use for which load and which additional programs are also available to you.

	Universal-Program	Quick-Program B	Quick-Program S	Gentle-Program	Prion-Program
Sterilization temperature	134 °C	134 °C	134 °C	121 °C	134 °C
Sterilization pressure	2.1 bar	2.1 bar	2.1 bar	1.1 bar	2.1 bar
Sterilization time	5:30 min	5:30 min	3:30 min	20:30 min	20:30 min
Operating time ^{*)} Vacuklav 41 B+	c. 23 min	c. 16 min	c. 12 min	c. 40 min	c. 38 min
Operating time ^{*)} Vacuklav 43 B+	c. 25 min	c. 16 min	c. 13 min	c. 42 min	c. 39 min
Intelligent drying ^{**)}	4 - 30 min	4 - 30 min	4 - 30 min	4 - 30 min	4 - 30 min
Time-controlled drying	12 min	c. 6 min	c. 2 min	12 min	12 min
^{*)} without drying, with a full load and dependent on the load and set-up conditions (such as cooling water temperature, if a fixed water connection is present and the mains voltage)					
^{**)} Drying Activation of the intelligent drying subjects the drying phase to automatic managing and ends as soon as the load is dry.					

Program name	Packaging	Especially suitable for	Load ^{*)} 41 B+/43 B+
Universal-Program 	Single and multiple wrapping	Mixed load, long narrow-bore hollow bodies	6 kg/7 kg or 9 kg with MELAstore ^{**)}
Quick-Program B 	Single wrapped and unwrapped instruments (no textiles)	Long narrow-bore hollow bodies	single wrapped max. 1.5 kg ----- unwrapped 6 kg/7 kg
Quick-Program S 	Only unwrapped (no textiles)	Single massive instruments, transfer instruments, simple hollow bodies	6 kg/7 kg
Gentle-Program 	Single and multiple wrapped	Textiles, thermo-unstable items (e.g. plastic, rubber articles)	Textiles 2 kg/2.5 kg ----- Thermo-unstable equipment 6 kg/7 kg or 9 kg with MELAstore ^{**)}
Prion-Program 	Single and multiple wrapped	Instruments under suspicion of carrying the danger of infection through abnormally altered proteins (e.g. Creutzfeld-Jacob, BSE)	6 kg/7 kg or 9 kg with MELAstore ^{**)}

^{*)} The max. weight per component is 2 kg for instruments or textiles.

^{**)} The drying was checked for 9 kg load with MELAstore Box. The drying of other large weights (6/7 kg to 9 kg wrapped) or other load configurations must be checked individually and locally. **Additional drying** may be required.

Additional programs		Use/function
Vacuum test		For measuring the leakage rate, test with a dry and cold device (test without load)
Bowie & Dick test		Steam penetration test with special test package (available from specialist stockists)
Conductivity meas.		For manual measurement of the feed water quality
Drain		For draining and pressure release of the double jacket steam generator, e.g. for service, maintenance or before transport

Additional program options

Additional drying

Used with the types of load specified in this chapter, the program-specific drying times guarantee very good drying of the sterile material. For difficult drying tasks you can activate the additional drying function retrospectively during a running program, see [Additional drying](#) [▶ page 56].

Start time pre-selection



NOTICE

Unsupervised operation of electrical devices, including this steam sterilizer at the operator's risk. MELAG accepts no liability what so ever for any damage resulting from unsupervised operation.

This function enables you to select any program and start it at a time of your choice. The start time pre-selection is only active for the unique time and program selection. That means that after completion of the program, the pre-selected start time expires. You can switch off the steam sterilizer during the start time pre-selection. However, the steam sterilizer must be switched on before the timer runs out.

Please note, the security query means that this function is not possible for Quick-Program S. To set a program start to a particular number, proceed as follows:

1. After selecting the program, press the  symbol in the action bar. The display switches to the settings window.

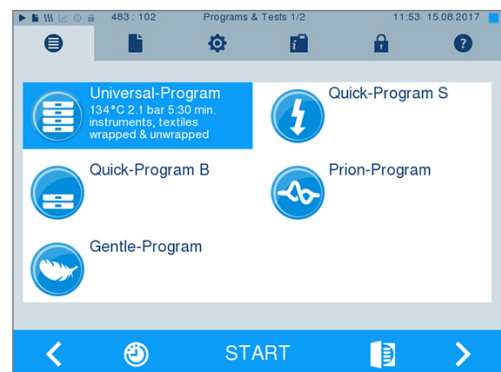

- For example, to change the time, tap directly on the parameters **Hour** or **Minutes**. The selected field is highlighted light blue.

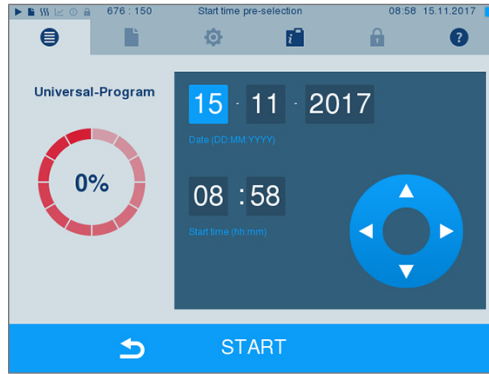

- Change e.g. the hour by pressing the pushbuttons

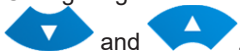

- Then press **START**. The display remains in the start time pre-selection window.

➔ After the start of the start time pre-selection no other menu apart from the **Info & Status** menu can be selected.

Starting the program

With the start of the program, the door closes pressure-tight and the steam sterilizer checks the quantity of feed water and its conductivity.

- To start a program, press the **START** key.

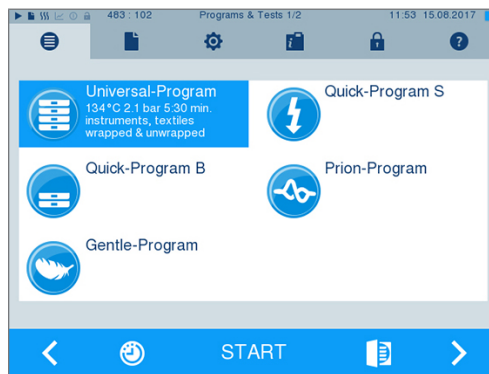

- With activated user authentication: Enter the user PIN or press (if possible) the button to

skip this stage  (see [User administration](#) [▶ page 52]).

PLEASE NOTE: Only ever use the “Skip user authentication” function in an emergency.

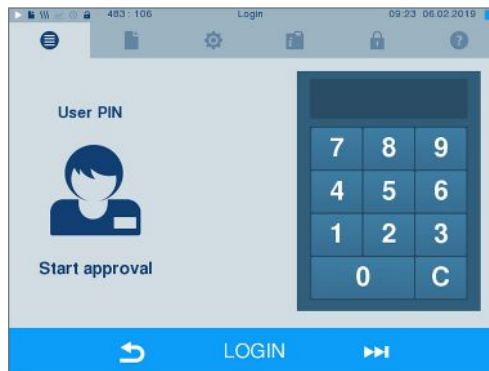

PLEASE NOTE

When starting Quick-Program S, a warning and an acoustic signal indicates that this program is suitable only for the sterilization of unwrapped instruments. If the load contains unwrapped instruments only, confirm with **YES**, to start the program.

Program run

A program runs in three main phases: the air removal and heating up phase, the sterilization phase and the drying phase. After program start, you can follow the program run on the display. It shows the chamber temperature and pressure as well as the time until the end of sterilization / drying.

Air removal and heating up phase

During this phase, the steam will be injected and removed from the sterilization chamber (conditioning) to generate over-pressure which removes residual air. Then, during fractionation, the mixture of air and steam is evacuated from the sterilization chamber and steam is injected. This reduces the level of residual air in the sterilization chamber to a minimum. At the same time, the requirements for pressure and temperature are created for sterilization.

Sterilization phase

In the sterilization phase, pressure and temperature are held in the area required for sterilization.

The display indicates whether the sterilization phase has been completed successfully. The coloured ring and the LED status bar switches from blue to green as soon as the drying phase has been introduced.

The sterilization phase is unsuccessful if the operator or the system (responding to a malfunction) aborts the program run. A system abort returns the steam sterilizer to a pressureless state. This explains why a system abort takes longer than an abort by the user.

Drying phase

The steam sterilizer provides excellent drying of the load. Depending on the setting, drying is performed either via the time-controlled drying or the pre-set intelligent drying (see [Intelligent drying](#) [▶ page 56]). If difficult-to-dry items require better drying, you can undertake the following steps to improve drying:

- ▶ Load the steam sterilizer properly. Stand e.g. the transparent and paper sterilization packaging upright. Comply with section [Loading the steam sterilizer](#) [▶ page 24]. Use the optional package holder if necessary.
- ▶ Time-controlled drying: Activate function **Additional drying**, to extend the drying time by 50 %.
- ▶ Intelligent drying: Activate function **Additional drying** to restrict the criteria for ending the drying phase.

Following the program run on the computer

You can follow the current progress of a sterilization program on every computer in the practice network.

✓ *The steam sterilizer has been assigned an IP address and is integrated in the practice network.*

1. Open a web browser (we recommend Mozilla Firefox or Internet Explorer/Microsoft Edge) and enter the IP address of the steam sterilizer in the address bar of the web browser e.g. 192.168.57.41.

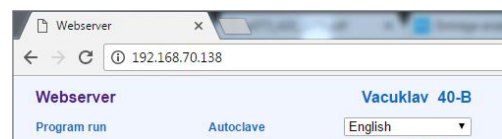

- Confirm with [ENTER]. Now you can display the program run or information about your steam sterilizer (e.g. serial number, device software version and selected values).



Manual program abort

You can abort a current program in all phases. If you abort the program before drying begins, the load remains **unsterile**.



WARNING

Hot steam can be released from the device when opening the door after a program abort. This could result in scalding.

- Use a tray lifter to remove the tray.
- Never touch the sterile material, the sterilization chamber or the door with unprotected hands. The components are hot.

Program abort before the start of drying



WARNING

Danger of infection from early program abort

Aborting a program before the drying phase begins means that the load is unsterile. This endangers the health of your patients and practice team.

- Re-pack the load if necessary.
- Repeat the sterilization of the load.

Should you still wish to do so, proceed as follows to abort the program before drying:

- Press CANCEL on the action bar.

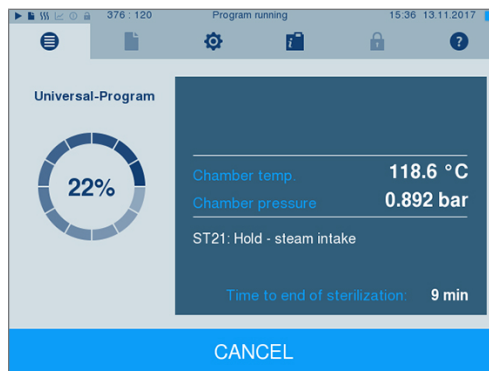

- Confirm the security query with YES.

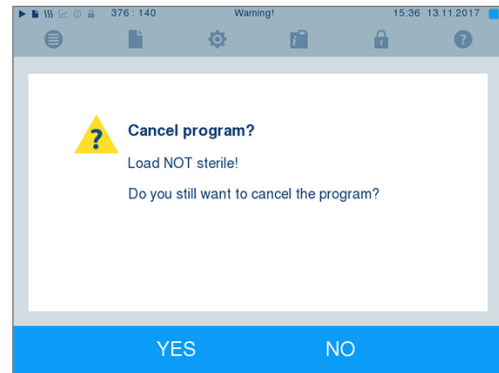

- After a short time, you can open the door by pressing the  symbol. The display shows a warning; the log records the sterilization as **NOT successful**.

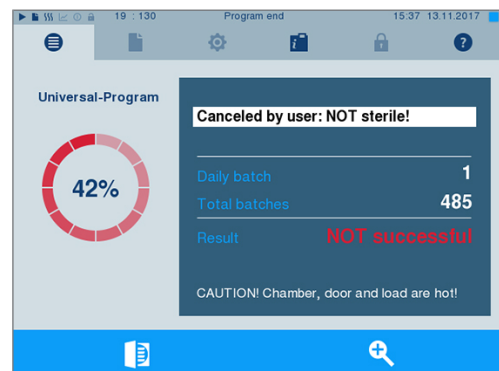

Program abort after the start of drying

Should you abort a program after drying has started, the sterilization is having been completed successfully. The steam sterilizer issues a malfunction message. You then need to expect insufficient drying, especially in the case of wrapped sterile material and a full load. Sterile storage requires sufficient drying. To ensure this, please allow programs with wrapped sterile material to continue to the end of the drying phase as far as is possible. Unwrapped instruments sterilized in a Quick-Program dry from their own warmth after being removed.

Proceed as follows to abort the program during drying:

- Press STOP on the action bar.

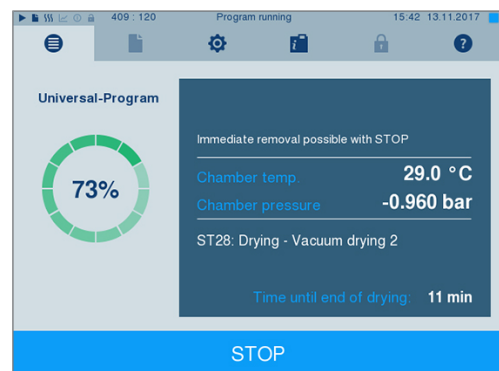

- 2. Confirm the security query with YES.

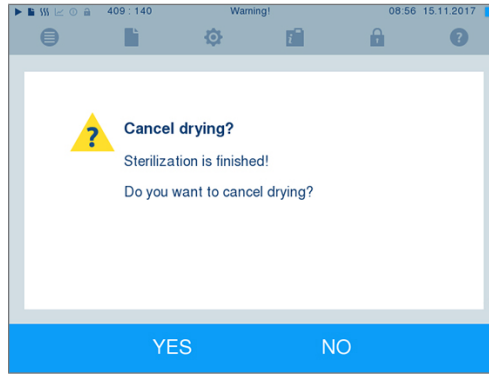

- 3. After a short time, you can open the door by pressing the door symbol .

Program end

When the program has ended successfully, the corresponding message will be issued on the display. Before opening the door, you can view further values on the display from the program which has just completed, e.g. the plateau time or conductivity etc. by pressing the zoom symbol .

- ▶ Press the door symbol  to unlock the door.

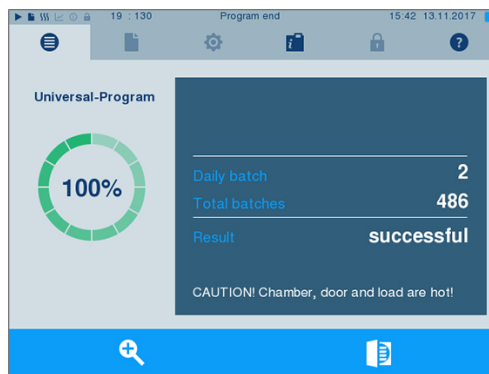

If automatic logging after program end is activated (= Immediate output) in the **Settings > Logging** menu, the log of the completed program will be outputted to the activated output medium after opening the door.

The approval process

Video tutorial

See also "Approving the sterilization batch".



According to RKI "Hygiene requirements for the treatment of medical products", instrument treatment ends with the documented approval for storage and application of the sterile material. The approval process consists of batch indication and batch approval and must be performed by authorized and expert personnel. This is ensured by the activated user authentication. To do so, enter the user PIN (see [Settings](#) ▶ page 46]).



PLEASE NOTE

Skipping user authentication means that the batch is not approved.

- Only ever use the “Skip user authentication” function in an emergency.

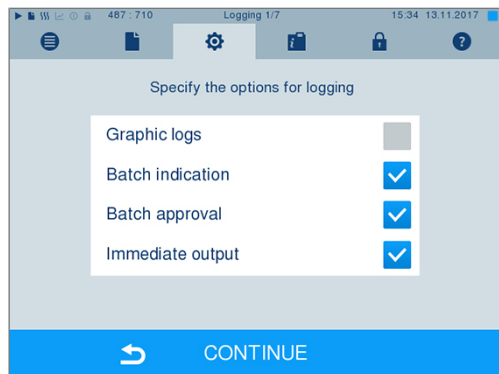

Batch indication comprises the checking of the indicators used in the sterilization program e.g. MELAcontrol Helix or MELAcontrol Pro. Approval of the indicator strip is possible only if it changes colour entirely.

Batch approval comprises the checking of the process parameters using the sterilization results on the steam sterilizer and the sterilization log as well as checking of the individual packaging for damage and residual moisture. The sterilization log records the approval of the batch and any indicators. Depending on the setting in the user administration, approval for the sterile material requires the user PIN of the person who provides approval for the batch and the indicators.

Removing the sterile material



CAUTION

Danger of burns from hot metal surfaces

- Allow the device to cool sufficiently before opening.
- Do not touch any hot metal parts.



CAUTION

Unsterile instruments resulting from damaged or burst packaging. This endangers the health of your patients and practice team.

- Should the packaging be damaged or have burst after sterilization, wrap the load again and re-sterilize it.

If you remove the sterile material from the device directly after the end of the program, it is possible that the instruments can be partially damp. According to the red brochure of the Arbeitskreis für Instrumentenaufbereitung (AKI), the tolerable residual moisture is – in practice – a few drops of water capable of evaporating within 15 min, but actual pools of water are not acceptable.

Comply with the following specifications when removing the sterile material:

- ▶ Never use force to open the door. This could damage the device or result in the emission of hot steam.
- ▶ Hold the mount level when removing it from the device. Otherwise, the load could slide off.
- ▶ When removing the load from the device separately, ensure that the mount does not slide out unintended.
- ▶ Use a tray lifter to remove the tray.
- ▶ Never touch the sterile material, the sterilization chamber, the mount or the inside of the door with bare hands. The components are hot.

- ▶ Check the packaging of the sterilized equipment for damage when removing it from the device. Should the packaging be damaged, re-pack the load and re-sterilize it.

Storing sterile material

The maximum storage time is dependent on the packaging and the storage conditions. Please observe the regulatory requirements for the storage period of sterile materials (in Germany e.g. DIN 58953, Part 8 or the DGSV guidelines) as well as the following listed criteria:

- ▶ Comply with the maximum storage duration in accordance with the packaging type. Comply with the manufacturer's information on the packaging.
- ▶ Do not store the sterile material in the reprocessing room.
- ▶ Store the sterile material in a dust-protected environment e.g. in a closed instrument cabinet.
- ▶ Store the sterile material in an environment protected against moisture.
- ▶ Store the sterile material in an environment protected against excess temperature variations.

8 Logging

Batch documentation

Video tutorial

See also „Process documentation“.



The batch documentation serves as proof of the successful conclusion of the program and represents an obligatory part of quality assurance. The device internal log memory saves such data as the program type, batch and process parameters of all the programs completed.

To obtain the batch documentation, you can output the internal log memory and transfer its data to various output media. This can be performed immediately at the end of every program or at a later point, such as at the end of the day.

Capacity of the internal log memory

The steam sterilizer is equipped with an internal log memory. This saves all the data regarding the sterilization program automatically. The capacity of the internal log memory is sufficient for approx. 100 logs. If the internal log memory becomes almost full and at least one log has not been outputted via an activated output medium, the following warning **Internal log memory is almost full** will appear on the display. If this warning appears, working in the **Settings** menu > **Logging** provide the pre-determined output media and output the logs affected (**Log output** menu).

Shortly afterwards, the following message is displayed: **Internal log memory full**. You now have the last chance to archive logs which have not been outputted (confirm query with **YES**) before the data in the steam sterilizer log memory (up to the last 40 logs) is automatically deleted.

Output media

You are able to output and archive the logs of the completed programs on the following output media:

- MELAflash CF card
- Label print-out with the MELAprint 60 label printer
- MELAprint 42/44 log printer
- A computer (via the practice network)

Any combination of the output media is possible. Log output on multiply activated media is performed successively. In its delivery state, the MELAflash CF card is activated as the output medium for text and graphic logs from the steam sterilizer. Automatic logging (= Immediate output) is thus activated.

Detailed information regarding the activation and setting of log output is to be found in the chapter [settings, logging](#) [▶ page 46].

Using the CF card as an output medium



NOTICE

Premature removal of the CF card from the card slot or its inappropriate handling can result in data loss, damage to the CF card, the device and/or its software.

- Never push the CF card in the slot with force.
 - Never remove the CF card from the slot whilst it is being written or read. The square in the upper right-hand corner of the display lights up during reading and writing access.
-

The card slot for the CF card is located on the right-hand side of the display housing.

Proceed as follows in order to insert the CF card in the slot.

✓ *The CF card is set as the output medium in the **Settings > Logging menu.***

1. Insert the CF card in the card slot fully with the raised finger edge pointing rightwards and to the rear. If the CF card is inserted correctly, a blue square will illuminate in the right upper corner of the display.

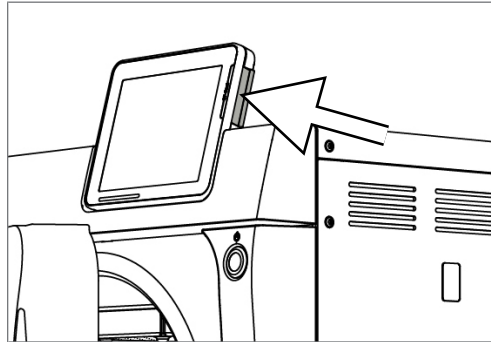

2. Check whether the CF card has been selected as the output medium.

Using the computer as an output medium

You can connect the steam sterilizer directly to a computer or integrate it in an existing (practice) network via FTP or TCP. The computer must be fitted with a RJ45 socket (LAN).

Further information pertaining to the requirements and setting of the computer as an output medium is available in the chapter [Settings, logging](#) [▶ page 46].

Reading out a text log on the computer

All text logs can be opened and printed using a text editor, a word processing program or a spreadsheet program. Graphic logs can only be displayed with the MELAtrace/MELAvue documentation software.

Each text log (e.g. .PRO, .STR, .STB etc.) must be linked with the text editor to enable the computer to open them automatically with a text editor. The meanings of the endings are outlined in the section [Subsequent log output](#) [▶ page 39]. The following example shows how you can link the Windows 10 editor with a specific text log.

1. In Windows Explorer double click on the log file.
2. If the file ending is unfamiliar, Windows 10 will display the following message:

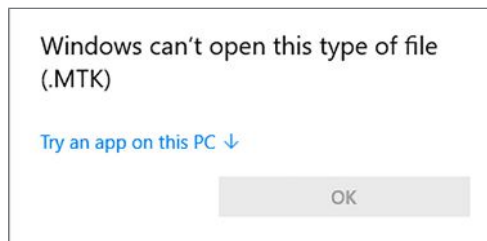

3. Select "Try an app on this PC".

4. Mark the Notepad and confirm with "OK".

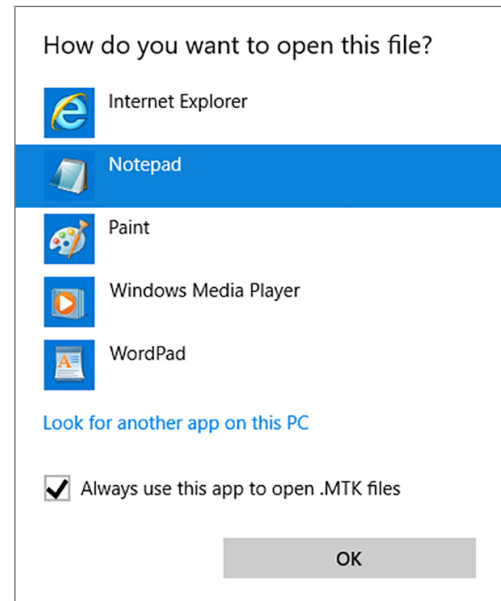

→ You can then open files with this ending via a double-click in Notepad.

Using the label printer as an output medium

The use of a label printer facilitates batch traceability. Using the sterilization date, the storage duration, batch number, user ID of the person approving the application for use, the steam sterilizer used and the file name it is possible to assign the sterilized instruments to the patient and sterilization batch. Faultless packages containing sterile material are marked with labels after sterilization. As such, the preconditions for correct "Approval" by the person conferred with the task of reprocessing are given. All information regarding the correct sterilization procedure can be attributed to the instruments used in patient records.



PLEASE NOTE

To facilitate easy assignation of a package marked with a label to a specific batch, the sterilization log file name must not be changed.

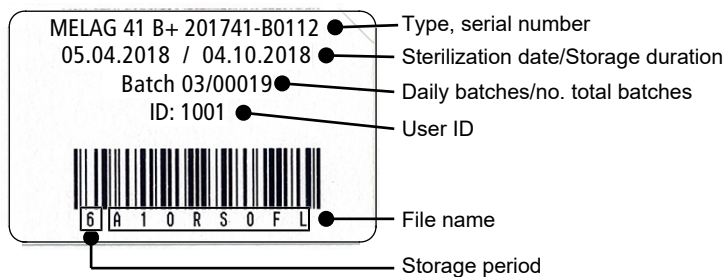

Outputting text logs automatically after program end (immediate output)

Should you wish to output the associated text and graphic logs (optional) on an output medium immediately after the end of a program, use option **Immediate output**. In its delivery state, the immediate output of the text and graphic logs via the CF card after program end is activated.

If the output medium selected for this purpose has not been connected, the logs are saved in the internal memory and a warning is issued. The steam sterilizer provides the option of outputting this log at the next possible opportunity. Graphic logs cannot be saved in the internal log memory; they are lost. Further information pertaining to the output of graphic logs is available in the section [Outputting graphic logs \(optional\)](#) [▶ page 46].

The following points must be fulfilled for immediate output:

- ▶ The date and time have been set correctly.
- ▶ The output medium must have been selected and connected.
- ▶ Immediate output must be activated in Menu **Settings > Logging**.

Information regarding the setting of immediate output and the desired output medium is provided in the chapter [Settings, logging](#) [▶ page 46].

Subsequent log output

Menu **Log output** provides the option of outputting text logs subsequently and independently of the point of the program end. You can set the output media yourself. The output media are pre-selected as standard, which are also selected under **Settings > Logging** as far as automatic immediate output has been activated.

Menu **Log output** provides various opportunities for log output. Menu **Logging list** displays all the program logs present in the memory. You can sort the list according to date, time, program and outcome by pressing on the column headings. Here is an overview of all possible output media.

Designation	File ending	Explanation
Last log	.PRO	The log of the last successful completed program is outputted.
Logs of the day	.PRO	The log of the last successful program of the current day is outputted.
Logs of the week	.PRO	Logs of all successfully completed programs of the week - Monday to Sunday - will be outputted
Logs of the month	.PRO	Logs of all successfully completed programs performed in the current month will be outputted.
All logs	.PRO	The logs of all successfully completed programs will be outputted.
Last fault log	.STR	The last malfunction log is outputted.
Fault logs of the day	.STR	The malfunction logs of the current day are outputted.
etc.	...	
Legend log file	.LEG	Contains an explanation of all abbreviations contained in the log.
Status log	.STA	A summary of all important settings and system states (counter, measured values etc.)
Fault in standby	.STB	This log type is generated following malfunctions during a time at which no program was active.
System log	.LOG	A sort of logbook listing all malfunctions and changes to the system in order of their incidence.
Delete all logs	--	Deletes all logs stored in the internal log memory. Notice: All logs will be deleted which were not previously outputted to another output medium.

Outputting a log from the log list

Proceed as follows to output a specific log from the internal memory:

1. Navigate to menu **Log output** and select **Logging list**.

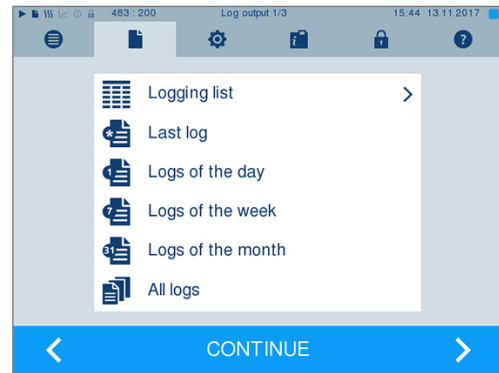

2. A list is displayed with all text logs that have been saved in the internal memory. To facilitate the search, you can filter the log sorting sequence by date, program or outcome by selecting the top line.

No.	Date	Time	Program	Result
484	10.08.2017	15:35	Universal-Program	ER_D
483	10.08.2017	15:34	Universal-Program	ER_D
482	10.08.2017	15:31	Universal-Program	OK_D
481	10.08.2017	14:25	Universal-Program	ER_D
480	10.08.2017	14:21	Universal-Program	OK_D

3. Select a log and press **CONTINUE**.
4. Select an output medium if required and press **OUTPUT**.

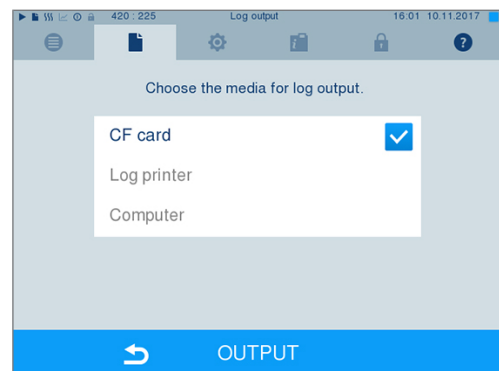

Outputting the daily / weekly log etc.

Proceed as follows e.g. to output all the logs of a week:

1. Navigate to menu **Log output** and select option **Logs of the week**.

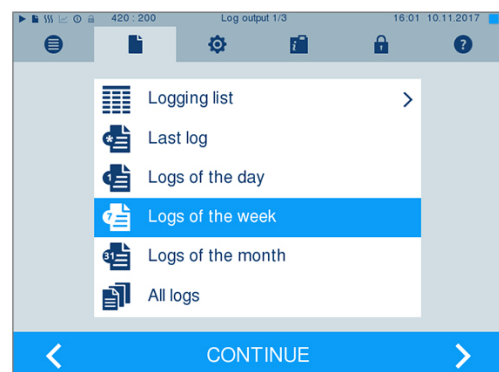

2. Press **CONTINUE**.

3. Select an output medium if required and press OUTPUT.

Proceed in a similar fashion to output the last log or all the logs of that day or month or all logs.

Finding logs



PLEASE NOTE

If possible, do not rename the directories, otherwise logs will be stored in both the renamed directory as well as the new device directory generated automatically by the steam sterilizer.

Storage location for logs

When transferring the logs to a CF card, they will be stored in a separate folder in the main directory. Direct transfer of the logs to a computer via the network and using the MELAG FTP server allows you to work directly in the FTP server to determine directly where on your computer the device directory with log files is to be saved. With output via TCP and e.g. MELAtrace, you can work directly in the program to determine the folder in which they are to be saved.

Log directory

A folder is created on all memory media (CF card or computer) after log output containing the encoded serial number of the steam sterilizer concerned. The folder name consists of five characters identical with the first five characters of every log, e.g. E00T7. This folder contains sub-folders with the month of log generation e.g. 01_2016 for January 2016. This contains all logs generated by the steam sterilizer this month. The device directory is entered in the main directory on the CF card.



The steam sterilizer checks the memory medium after every type of log output (immediate output after a completed cycle or the transfer of multiple logs simultaneously). Should a directory not exist, it automatically creates a directory for the device and the month. If the logs are subject to multiple outputting on the identical memory medium, the device directory will create a "Duplicate" directory.

Further information pertaining to the meaning of the file endings on the logs is available in section [Subsequent log output](#) [▶ page 39].

Example log of a successfully completed program

<pre> ----- !0 01100ED0E001 !1 E00T717U.PRO ----- 10 MELAG Vacuklav 41 B+ ----- 15 Program: Universal-Program 20 Program type: 134 °C wrapped 25 Date: 09.03.2017 30 Daily batch: 14 Total: 01578 34 ID load: 1001 35 ID approval: 1001 36 Indicators changed: deactivated 37 Batch released: deactivated ===== 40 Universal-Program ended successfully 42 = = ===== 45 Temperature: 135.3 +0.25/-0.18 °C 50 Pressure: 2.17 +0.02/-0.01 bar 55 Plateau time: 05 min 30 s 60 Conductivity: 8 µS/cm (359:11.1) 65 Start time: 20:22:01 70 End time: 20:43:19 (21:18 min) ===== 80 SN:201441-B1051 ===== 81 MR V3.218 09.03.2017 82 Para V3.226 17.02.2017 83 BO V3.323 09.03.2017 ----- Step Time t[m:s] P[mbar] T[°C] SP-S 0:00 0:00 1002 96.3 SK11 0:13 0:13 1680 95.7 SK12 0:37 0:24 1285 104.8 SK11 0:46 0:09 1665 106.8 . . SK22 2:38 0:20 1284 116.6 SF12 3:12 0:34 499 112.7 SF13 3:42 0:30 1667 113.3 . SF43 8:25 0:24 1749 113.6 SH01 9:10 0:45 2780 130.5 SH02 9:31 0:21 2847 131.7 SS01 9:53 0:22 3065 134.0 SS02 15:23 5:30 3169 135.3 SA00 15:53 0:30 1292 112.1 SI02 17:33 1:40 79 57.9 . SB10 21:14 0:12 804 91.3 SB20 21:18 0:04 919 92.3 SP-E 21:18 0:00 925 92.3 >> Never change code on follow. line << 010041D8BE14B1319E55772A0DF975054F7EBF32 EE1372767ED3B3801EB10F3FB01A3212D41D7144 1C3B8B6474777962766F018680B68C56C219074F D6E7814D506F0A2F3077782541CC2CD05C425DA1 9A5EF5192C68174C868556542F7B8B05E97C6E46 16CDCFFA811E126FD67363FB74128A5F83AE6F37 F45A9E240C88615F1618D340060C1027205C83C2 >>Authentication of batch log<< ----- 0.00 0.0 0.0 0.0 ---.- 0.0 -edk---etm---etd---etp---etv---ett-END- </pre>	<pre> !0 Ident number !1 File name ----- 10 Steam sterilizer type ----- 15 Program name 20 Program sterilization parameters 25 Date 30 Daily and total batch number 34 User ID program start 35 User ID program end 36 Batch indication 37 Batch approval ===== 40 Control notification 42 Warning or malfunction message with program abort ===== 45 Sterilization temperature with max. deviations 50 Sterilization pressure with max. deviations 55 Sterilization time 60 Conductivity of the feed water 65 Time at program start 70 Time at program end ===== 80 Device serial number ===== 81 Current version of the device firmware 82 Current version of the device parameters 83 Current version of the user interface ----- Step – Program step Time – Time (minutes:seconds) which has elapsed since the program start t [m:s] – Duration (minutes:seconds) which a program step requires P [mbar] – Chamber pressure T [°C] – Chamber temperature Key for the program steps: SK – Conditioning SF – Fractionation SH – Holding SS – Sterilization SA – Pressure release ST – Drying SI – Intelligent drying SB – Ventilation SP-E – End Proof of authenticity (electronic signature)☐Should never be altered; decoding the code (by MELAG) indicates whether the data was generated on a MELAG steam sterilizer and has been changed. ----- Sensor measurement values are displayed here in the case of a malfunction. The values are helpful for a technician. </pre>
---	--

9 Function tests

Manual functional checks

You can follow the program run on the display via the values displayed there. You can also use the logs recorded for every program to determine the success of a program. The test programs enable you to perform an additional function check at any time.

Vacuum test

The steam sterilizer can be checked for leakages in the steam system using the vacuum test. This determines the leakage rate at the same time.

Perform a vacuum test in the following circumstances:

- Once a week in routine operation
- During commissioning
- Following longer operating pauses
- Following a malfunction (e.g. in the vacuum system)

Perform the Vacuum test with the steam sterilizer in a cold and dry state as follows:

1. Switch on the steam sterilizer at the power switch.
2. Working in the **Programs & Tests** menu, select Vacuum test and press START.

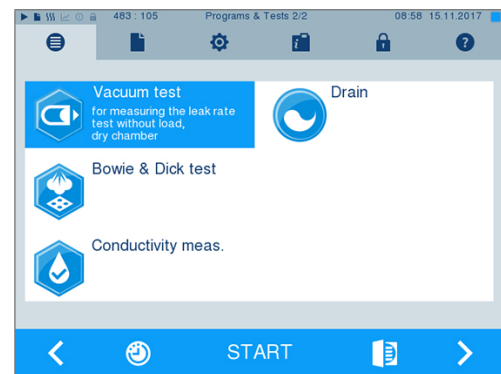

- The evacuation pressure and the equilibration time or measurement time are shown on the display. The chamber is ventilated after the end of the measuring time. Then the message will be shown on the display with an indication of the leakage rate. Should the leakage rate be too high i.e. over 1.3 mbar, a corresponding message will be shown on the display.

Bowie & Dick test

The Bowie & Dick test serves as proof of steam penetration of porous materials such as e.g. textiles. You can perform a routine function check for proof of steam penetration. Use test program **Bowie & Dick test** for this purpose. Specialist stockists provide various test systems for the Bowie & Dick test. Depending on the application, use either a test system for hollow body instruments or for porous load (laundry etc.). Combination test systems can also be used. Perform the Bowie & Dick test in accordance with the test system manufacturer's specifications.

1. Switch on the steam sterilizer at the power switch.
2. Place the test system in the sterilization chamber of the steam sterilizer and close the door.

- Working in menu **Programs & Tests** select **Bowie & Dick test** and press **START**.



Evaluation of the indicator following the colour change

Depending on the manufacturer batch, indicators often exhibit differing intensities in the colour change resulting from different lengths of storage or other influences. Of crucial importance for evaluating the Bowie & Dick test is not the strength of contrast in the colour change on the test sheet, but the uniformity of the colour change on the indicator. If the indicator indicates an equal distribution of colour change, the air removal of the sterilization chamber is without fault. If the indicators are uncoloured or exhibit less colour in the centre in comparison to the end, air removal was insufficient. In such a case, please consult the stockist customer services / authorised customer services.

10 Settings

Logging

All settings pertaining to the output of text and graphic logs i.e. output medium, log format, immediate output etc. are performed in menu **Settings > Logging**.

To this end, you are led through a settings wizard.

Immediate log output

In its delivery state, the immediate output of the text and graphic logs via the CF is activated.

Deactivating immediate output

If log output is not to be performed immediately following the end of a program, but saved in the internal memory, (e.g. to be collected and outputted together within a single week), you can deactivate the immediate output option. Proceed in the following fashion:

✓ You are in menu **Settings > Logging**.

1. Remove the checkmark in front of option **Immediate output**.

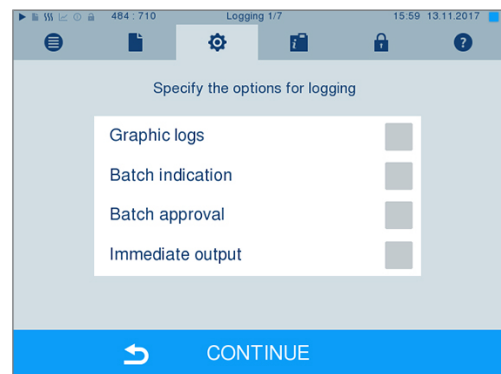

2. Press repeatedly on CONTINUE until you reach the summary window.
3. Press SAVE to save the setting.

Outputting graphic logs (optional)



PLEASE NOTE

Graphic logs cannot be saved in the internal log memory. A subsequent output of graphic logs is thus not possible.

If you wish to output a graphic log (optional) in addition to a text log, proceed as follows:

- ✓ You are in menu *Settings > Logging*.
- ✓ Immediate output is activated.

1. Set a checkmark next to **Graphic logs** and check whether the checkmark is also set next to **Immediate output**.

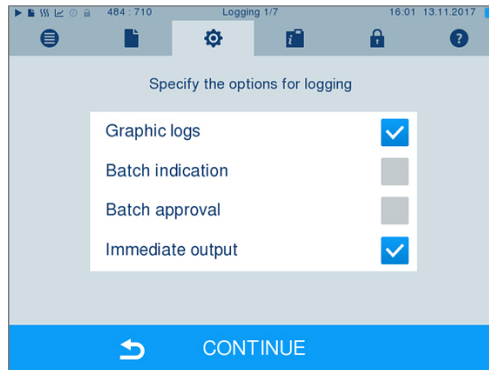

2. Press CONTINUE and select the CF card and/or the computer as the output medium.

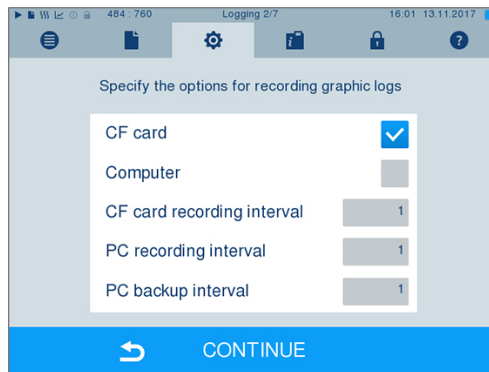

3. If necessary, change the intervals and press CONTINUE.

4. Working in this window, check whether at least one of the two output media have been selected for text logs.

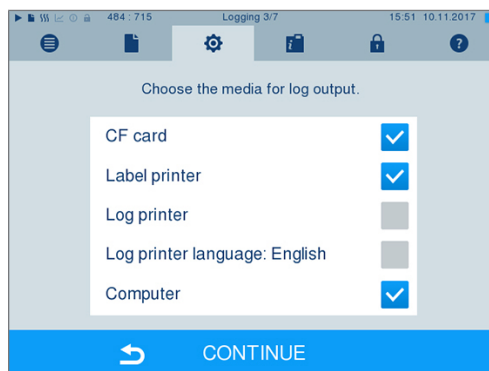

- 5. Check whether the activated output medium is connected (computer) or has been inserted (CF card).
- 6. Press repeatedly on CONTINUE until you reach the summary window.
- 7. Press SAVE to save the setting.

Explanation of the possible settings for graphic recording:

Interval	Explanation
CF card recording interval	in seconds – Indicates the time intervals in which the program curve is recorded on the CF card. The smaller the time interval, the more exact the curve. In the example, the time interval is set to one second.
PC recording interval	in seconds – Indicates the time intervals in which the program curve is recorded, if the computer is selected as output medium. The smaller the time interval, the more exact the curve. In the example, the time interval is set to one second.
PC backup interval	in seconds – Indicates the time interval in which the graphic data from the steam sterilizer is saved on the computer. In the example, the backup interval is set to one second.

Log output in English

If you want to print all text logs on the MELAprint log printer in English, proceed as follows:

- ✓ *The text log is to be printed in English, regardless of the language of the graphical user interface.*
- ✓ *You are in the menu **Settings > Logging**.*

1. Press repeatedly on CONTINUE until you reach the log output menu.
2. Select the **Log printer** as an output medium.
3. In addition, select **Log printer language: English**.

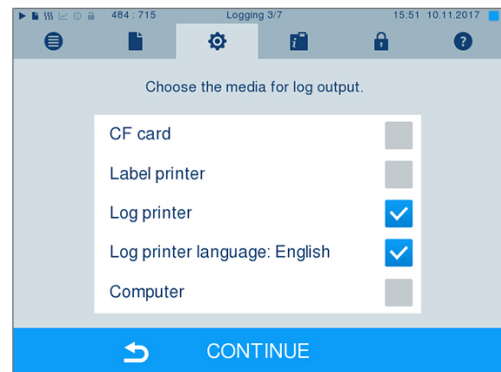

4. Press repeatedly on CONTINUE until you reach the summary window.
5. Press SAVE to save the setting.

➔ The output of the text logs on the MELAprint log printer is in English.

Using the computer as an output medium

Log transmission can be performed via an FTP server / service or TCP. The following section shows how to set the desired connection:

- ✓ *You are in menu **Settings > Logging**.*
- ✓ *The steam sterilizer is connected to a computer via a network cable (RJ45).*
- ✓ *Depending on the output type, an FTP server / service or a suitable program e.g. MELAtrace / MELAview is installed.*

1. Press CONTINUE until you reach the output media selection window.

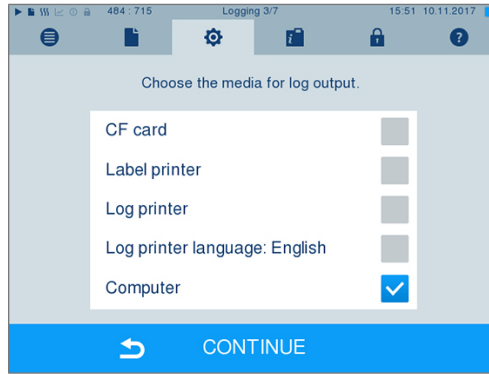

2. Select the computer as an output medium and press CONTINUE.

➔ The selection window opens and asks whether the connection to the computer should be effected via FTP or TCP.

Connection via FTP

✓ *An FTP server or an FTP service is installed on the computer.*

1. Select **Connection via FTP**. The lower pushbutton displays the current user data settings (standard user name: Year of construction + manufacture number; Password MELAG12345).



2. Press this pushbutton to change the pre-set TCP user data. The display switches to the settings window.

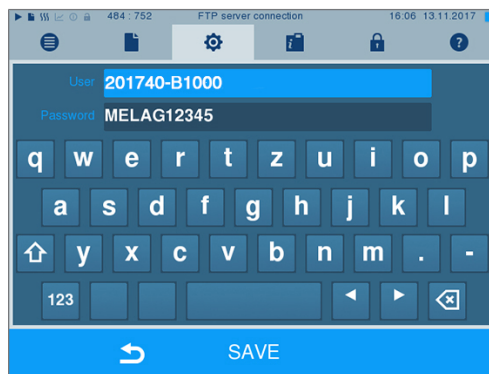

3. Enter the user name and password and confirm with SAVE.

Connection via TCP

✓ A suitable documentation software e.g. MELAtrace is installed.

1. Select **Connection via TCP**. The TCP port currently set is displayed on the lower pushbutton (Standard TCP port: 65001).



2. Press on the lower pushbutton to change the pre-set TCP port. The display switches to the settings window.

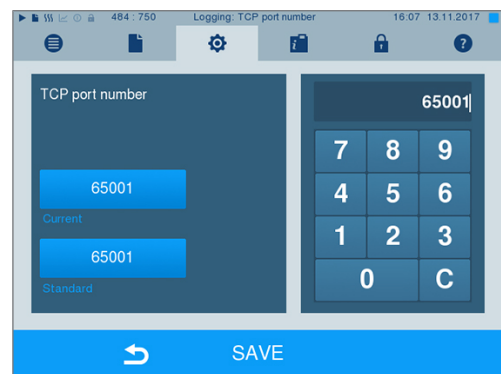

3. Delete the most up-to-date TCP port using key C; enter another TCP port.
4. Confirm with SAVE.

IP addresses



PLEASE NOTE

The setting up of the (practice) network will require in-depth understanding of the network technology.

Errors in the handling of IP addresses can result in malfunctions and data loss in your practice network.

- IP addresses may only be set by the (practice) network system administrator.

The device is equipped as standard with IP addresses which all belong to a common network with the subnet mask stated in the following depiction.

Device	IP address	Remarks
Steam sterilizer	192.168.40.40	Preset works side
Computer	192.168.40.140	Preset works side
MELAprint 42/44 log printer	192.168.40.240	Preset works side
MELAprint 60 label printer	192.168.40.160	Preset works side
Gateway	192.168.40.244	Not relevant within a network
Subnet mask	255.255.255.0	Possibly to be adopted by customer network

If a device is to be integrated in a pre-existing (practice) network, observe and comply with the following:

- ✓ *The IP addresses listed in the table have not yet been assigned in the (practice) network.*
- ✓ *The device cannot be automatically administered in a dynamic (practice) network (i.e. a DHCP network).*

1. Select menu **Settings** > **Logging**. The setting wizard opens.
2. Working in the logging assistant, navigate to the window in which the IP addresses of the individual devices are listed.

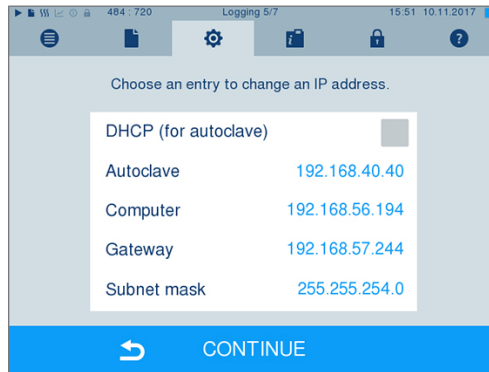

3. Select e.g. the steam sterilizer [autoclave]. The settings window opens.

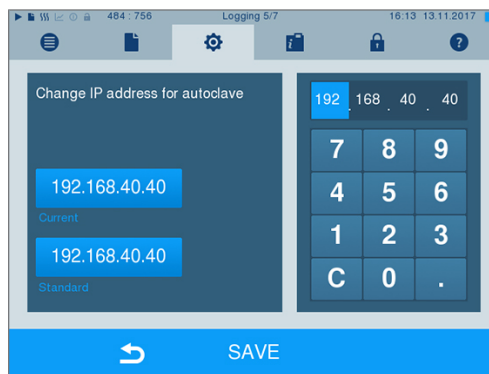

4. Select the number block which you wish to change directly.
5. Use the C key to delete the numbers. Enter a new number block and confirm with SAVE.
6. Proceed in a similar fashion with the other devices which are to be integrated in the network.

Log format

Different data is issued depending on the nature of the log format.

- ▶ The log format is determined under **Settings** > **Logging**.

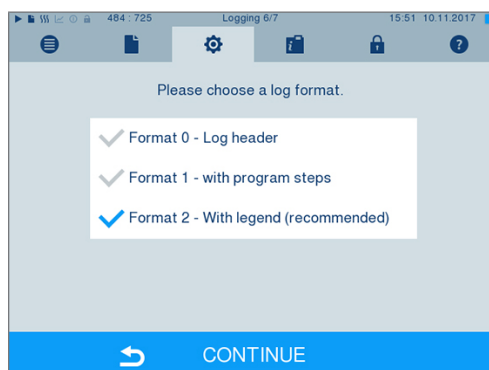

You can choose between the following formats.

Format	Description
Format 0	Short form - only the log header is outputted.
Format 1	The log header and the program steps are outputted.
Format 2	Standard format - in addition to the log header and the program steps, a key is displayed explaining the individual program steps. In logs outputted via the log printer MELAprint, the corresponding legend row is always located under the row to which it refers.

User administration

An ID and individual user PIN can be issued to every user with which to authenticate him/herself, so as to enable reliable traceability via the clearance process. You can determine the necessity of user authentication via a PIN in the **User administration** menu. Activation of this option documents the user ID and the outcome of the approval procedure in the log header.

Adding a user

1. Select menu **Settings** > **User administration**.

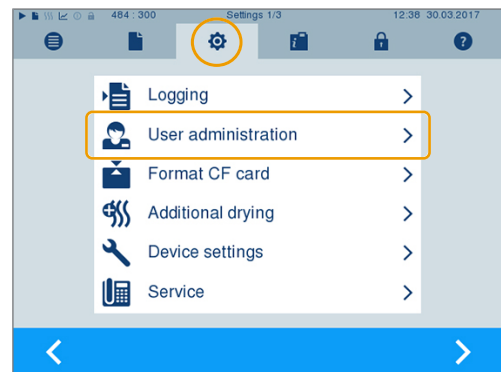

2. In order to access the **User administration** menu and perform settings, enter the Admin PIN (standard: 1000) and confirm with LOGIN. The display switches to window **User administration**.

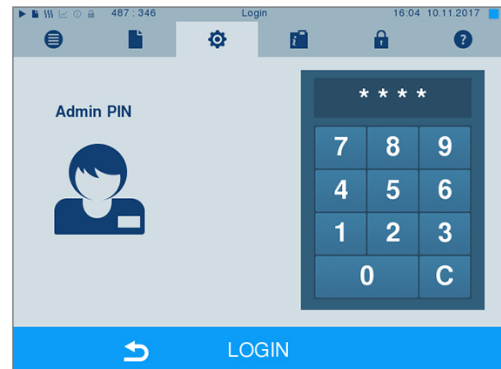

3. Select menu **User list** to display the user list.

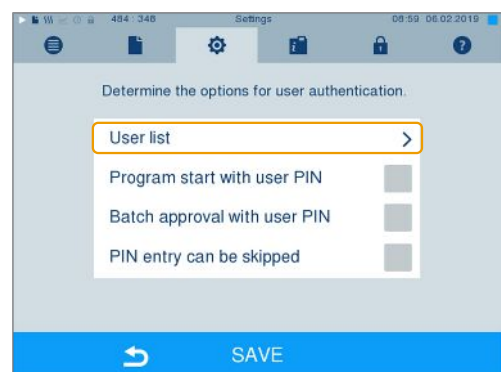

4. Select a free ID and select EDIT in order to create a new user. The first ID is reserved for the Admin PIN.

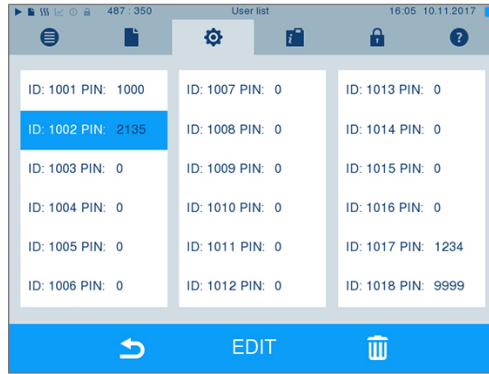

5. Enter a 4-digit PIN in the right-hand key pad for the selected user ID.

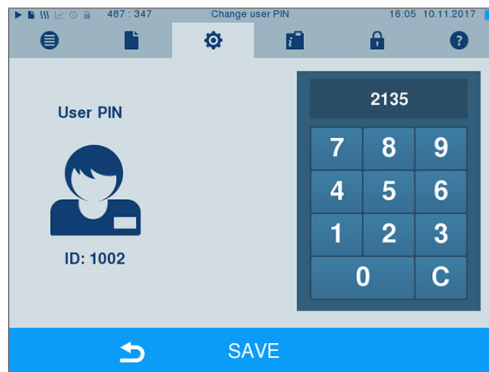

6. Accept all the settings with SAVE, then leave the menu.

7. Exit the menu by pressing this symbol .

Deleting a user

1. Select the **User administration** option as described above and open the user list.

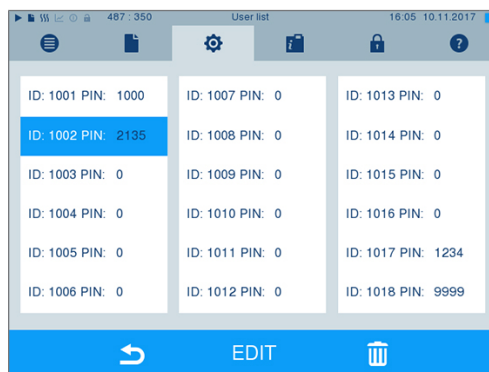

2. Select the user ID which you wish to delete.

3. Press the  symbol to delete this user.

↳ A warning is issued.

4. Confirming the warning with YES will set the PIN number of this ID to "0".

↳ A new PIN can be issued for this user ID at any time.

Changing the Admin PIN



PLEASE NOTE

If you forget the Admin PIN, consult your stockist/MELAG customer services provider.

The Admin PIN (standard: 1000) can be edited like every other User PIN and should be changed after delivery.

User authentication for sterilization

The user authentication can be set to ensure exact logging and verification. User authentication is performed by entry of the user PIN. The following settings are possible:

- Query user authentication upon program start
- Query user authentication upon program end
- Query user authentication upon program start and end
- You can skip the query user authentication

Determining options for the user authentication

1. Select menu **Settings > User administration**.

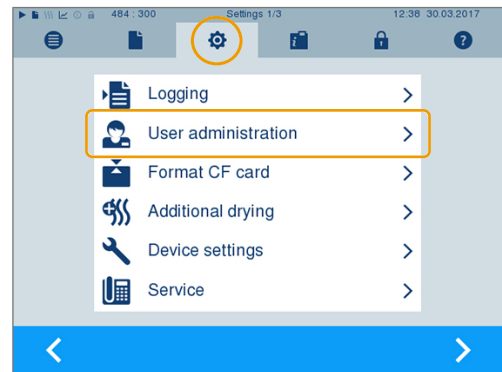

2. User administration menu and perform settings, LOGIN. In order to access the **User administration** menu and perform settings, enter the admin PIN (standard: 1000) and confirm with LOGIN. The display switches to window **User administration**.

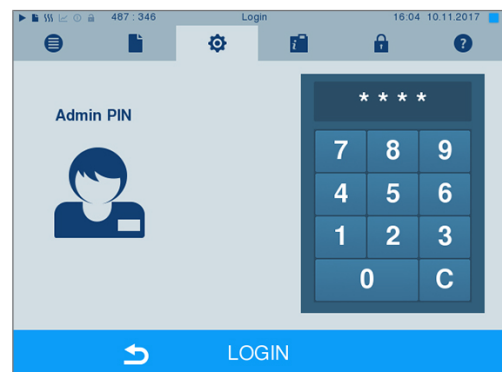

3. Set a checkmark next to **Program start with user PIN** to perform user authentication upon every program start. The program will start only after entry of the user PIN.

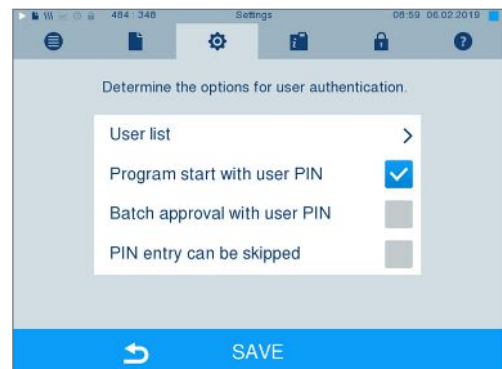

- Set a checkmark next to **Batch approval with user PIN**, to perform user authentication upon every program end. The device door will open following program end only after the user PIN has been entered.

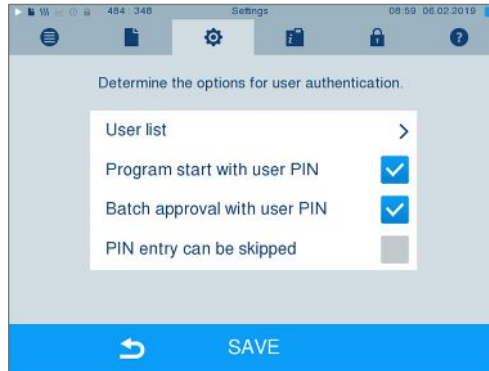

- Set a checkmark next to **PIN entry can be skipped** to enable the user PIN query to be skipped.

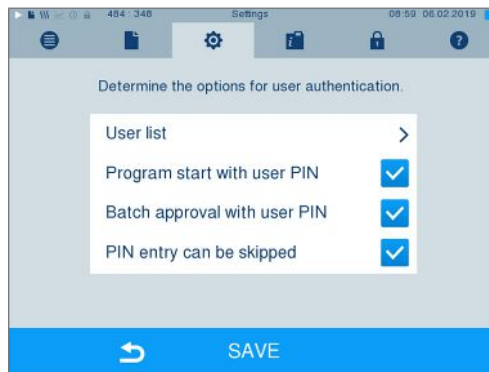

➤ The user PIN query continues to be displayed before program start or after program end. Press

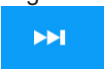
the key  to skip the user authentication.

- Accept all the settings with SAVE, then leave the menu.

Formatting the CF card



NOTICE

All data saved on the CF card is deleted during formatting.

- Check whether important data is stored on the CF card.
- Save any logs or other data on the computer or another memory medium.

- Insert the CF card in the steam sterilizer card slot correctly (tangible raised bar on the edge pointing back right). Do not use force.
- Select the **Settings > Format CF card**. The display switches to the corresponding window.

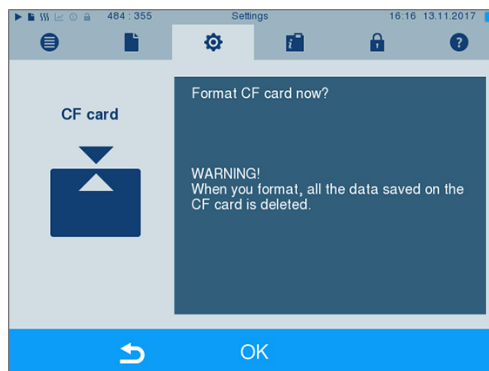

3. To start formatting, press the OK button. Confirm the security query with YES. You can remove the CF card as soon as formatting has been completed.

Additional drying

Selecting additional drying extends the drying time of conventional drying by 50 %. Activating intelligent drying restricts the criteria for ending the drying phase.

Activating/deactivating additional drying for all program runs

1. Select menu **Settings > Additional drying**. The display switches to the settings window.

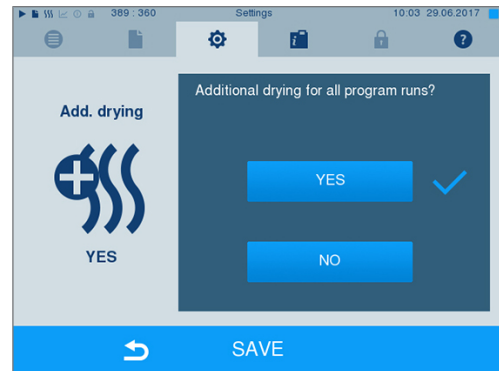

2. Press pushbutton YES or NO to choose whether additional drying should be performed during all subsequent program runs.
3. Confirm with SAVE.

Activating/deactivating additional drying for the current program run

You can activate or deactivate additional drying exclusively for the current program during the program run and into the sterilization phase. The settings during the program run are not carried over for the subsequent program runs.

1. Select the desired program.
2. Press START.
3. Select menu **Settings**. The display switches to the following window.
4. Place or remove the checkmark against option **Additional drying** and confirm with SAVE.

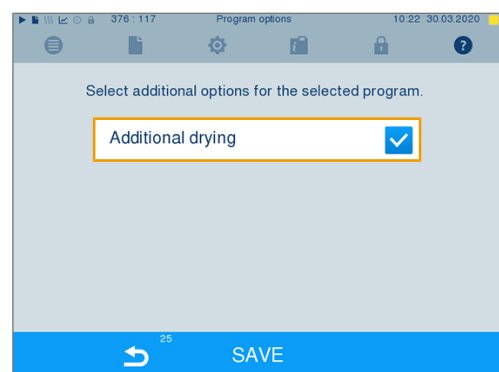

Intelligent drying

In contrast to a conventional time-controlled drying procedure, with which the duration of the drying phase is determined by the program, the duration of the intelligent drying is automatically calculated using the residual moisture in the sterilization chamber. A number of factors play a role in this process including e.g. the type of the load, wrapped or unwrapped, the load quantity, the distribution of the load in the sterilization chamber etc. Comply with the specifications in section [Loading the steam sterilizer](#) [▶ page 24].

Intelligent drying is activated in the delivery state. Should you wish to deactivate intelligent drying, proceed as follows:

1. Select menu **Settings > Device settings > Intelligent drying**. The display switches to the corresponding window.
2. If you wish to deactivate intelligent drying, select **NO**.

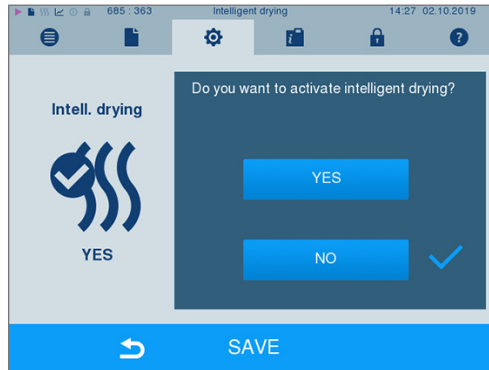

3. Confirm with **SAVE**.

Water supply

Select the corresponding setting in the display, depending on whether the feed water supply is effected using the internal storage tank or a water treatment unit:

1. Select the **Settings** menu.
2. Navigate to **Device settings > Water supply**.
 ↳ The display switches to the **Water supply** window.

3. Select **INTERNAL**, if the supply is to be performed via the internal storage tank or **EXTERNAL**, if you have connected a water treatment unit. **NOTICE! When connecting an external feed water supply it is necessary to connect an external wastewater outflow as well. There is a risk that hot wastewater might run through the emergency overflow.**

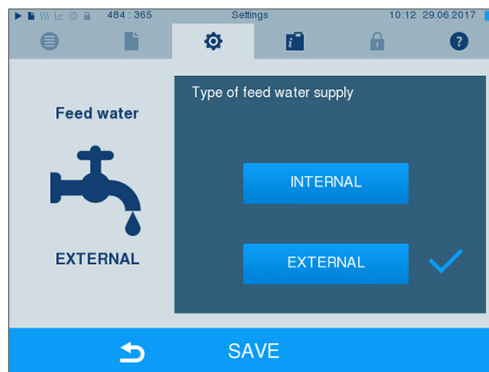



4. Confirm with **SAVE**.

Date and time

Correct batch documentation requires the correct date and time setting on the steam sterilizer. Ensure that you take into account the clock change in autumn and summer, as this is not adjusted automatically. Once the time has been set on the steam sterilizer, it is very accurate. Set the date and time as follows:

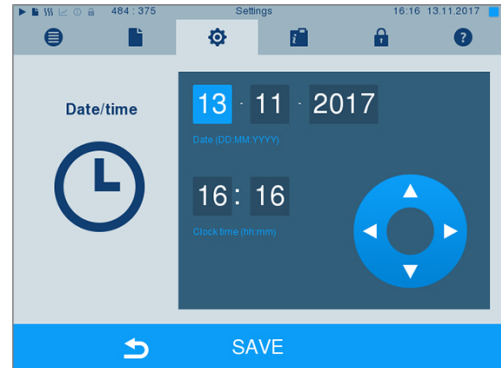
1. Select menu **Settings > Date & time**. The display switches to the settings window.





2. Select the parameters which you wish to change (day, month, year / hour, minute). The marked parameter is depicted light blue, here e.g. the day.
3. Change the respective value via the pushbuttons  and . Repeat this step for all the parameters which you wish to change.
4. Confirm the changes with **SAVE**.

➔ The display will be restarted after saving and then changes automatically to menu **Programs & Tests**.

Brightness

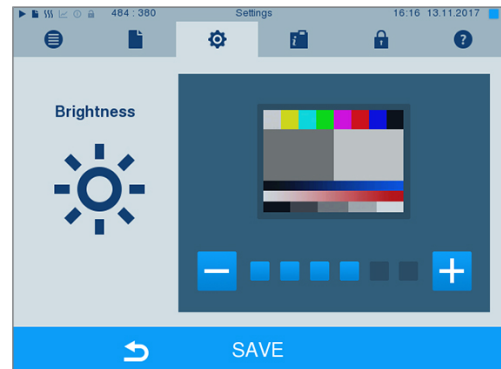
1. Select menu **Settings > Brightness**. The display switches to the settings window.



2. Press the pushbutton  or  to adjust the brightness and contrast on the display.
3. Accept all the settings with **SAVE** and then leave the menu.

Volume

1. Select menu **Settings > Volume**. The display switches to the settings window.

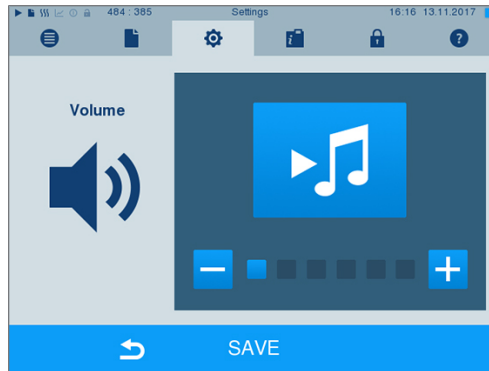

2. Press the **-** or **+** pushbutton to adjust the volume.
3. Accept all the settings with **SAVE** and then leave the menu.

View

You can choose between classic and modern view.

Switching from MODERN to CLASSIC

1. Select the **Settings > View** menu. The display switches to the settings window.

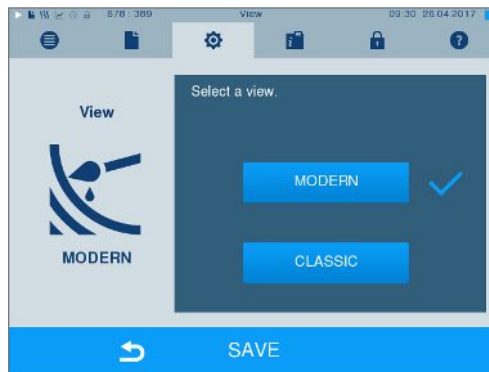

2. Press the **CLASSIC** button. The design changes immediately.

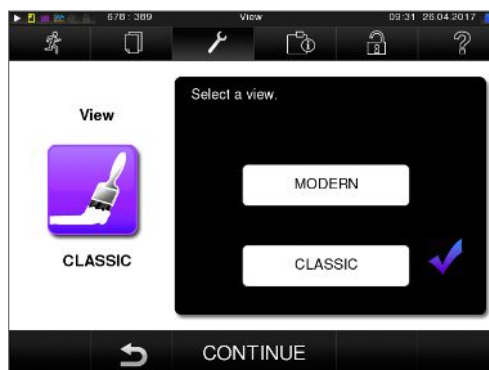

3. Press **CONTINUE**.

4. Tap on a colour box to change the background colour, e.g. blue. The background colour changes immediately and the white frame around the colour box shows which colour has just been selected.



5. Confirm the settings with SAVE. The display changes automatically to the **Settings** menu.

Switching from CLASSIC TO MODERN

1. Select the **Settings > View** menu. The display switches to the settings window.



2. Press the MODERN button. The design changes immediately.

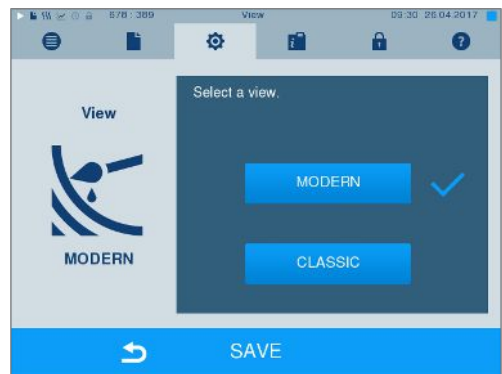

3. Confirm the settings with SAVE. The display changes automatically to the **Settings** menu.

MELAconnect

The MELAconnect app is used to monitor the preparation processes of your MELAG steam sterilizers on the mobile end device (e.g. smartphone, tablet).

The following must be fulfilled or present:

- ✓ The device is connected to the (practice) network.
- ✓ MELAconnect is installed on your mobile end device.
- ✓ You are in Menu *Settings* > *Connectivity*.

1. Select **MELAconnect**.

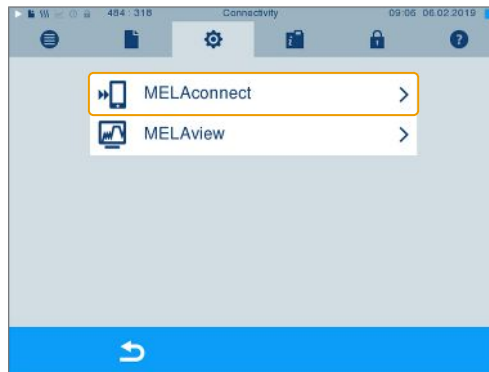

2. Open MELAconnect on your mobile end device.

3. Follow the instructions in MELAconnect and read in the QR code to connect your device to MELAconnect. Alternatively, you can enter the IP address of your device in MELAconnect manually.



↪ With manual entry of the IP address: Owners of multiple steam sterilizers of the identical device type can differentiate between their devices by viewing serial number on the display to check whether MELAconnect has been connected to the correct device.

Key tone

1. Select menu **Settings** > **Key tone**. The display switches to the settings window.

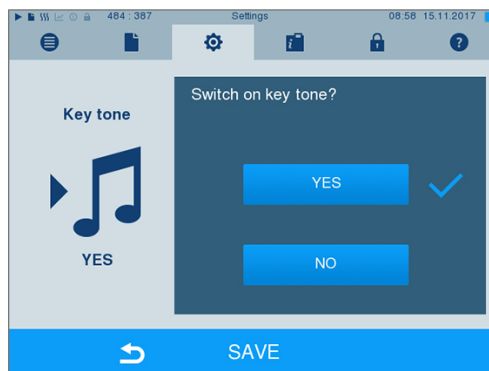

2. Press YES or NO to determine whether a tone should be emitted every time a pushbutton is pressed. This can be deactivated at any time.
3. Accept all the settings with SAVE and then leave the menu.

Screensaver

A screensaver can be activated to protect the display in standby operation. This displays a continuous slide show of any pictures.

Select images for the slide show

1. Select the **Settings > Screensaver** menu.

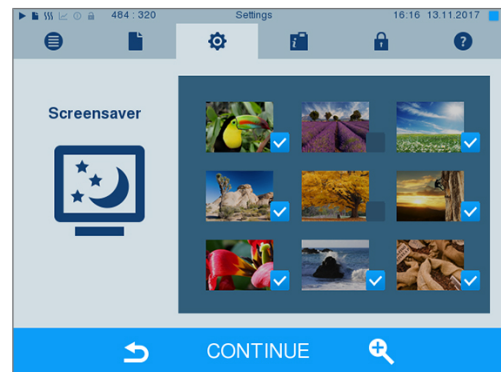



2. Tap on a picture to select it. The white frame around the picture indicates which picture is currently selected.
3. Repeated tapping on the picture selects/deselects it for the slide show.
 - ↳ The checkmark on the lower right-hand corner indicates whether the picture has been selected for the slide show.
4. Press CONTINUE to make further settings.

Setting the display duration of the pictures and the waiting time of the slide show

Proceed as follows to alter one of the named options:

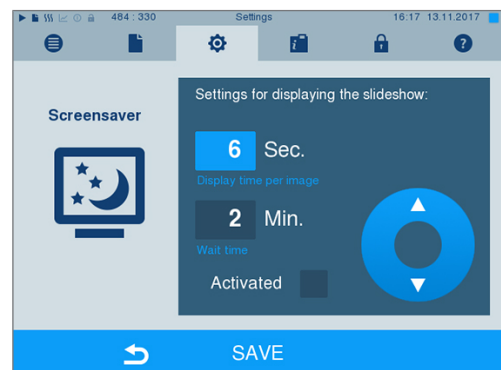
1. Select the parameter directly that you wish to change. The marked parameters are displayed light blue.



2. Change the respective parameter value via the  and  pushbuttons.
3. Confirm the settings with SAVE.
 - ↳ The display switches automatically to the **Settings** menu.

Explanation of the slide show options

Display duration per picture	indicates the time in seconds between the display of two separate pictures.
Waiting time	indicates how long the display remains in normal mode before the slide show starts.
Activated	Setting/unsetting the checkmark activates/deactivates the screensaver.

Log printer MELAprint 42/44

If you wish to output the sterilization log via the log printer MELAprint 42/44, you need to set this on the steam sterilizer once. The user manual of the log printer indicates how to set it up.

Label printer MELAprint 60

If you wish to output the sterilization logs via the label printer MELAprint 60, you need to set this on the steam sterilizer once. The user manual of the label printer indicates how to set it up.

Sensitivity

1. Select menu **Settings > Touchscreen sensitivity**. The display switches to the settings window.

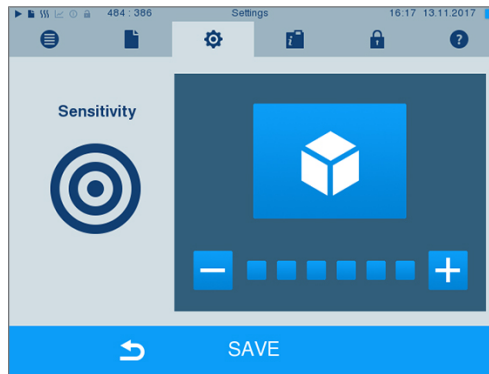

2. You can determine the pressure required to activate a pushbutton using the **-** and **+** pushbuttons.
3. Accept all the settings with **SAVE** and then leave the menu.

Energy-saving mode

If the steam sterilizer is not be switched off during longer operating pauses, it can be operated in energy-saving mode. This reduces the time which is required in order to pre-heat the double jacket steam generator to the necessary start temperature after deactivation. Two waiting times can be set in energy-saving mode:

Waiting time 1 (W1): After a pre-set waiting time of 15 min, the temperature of the double jacket steam generator falls to 103 °C. The program run time increases by approx. 2 min upon the next start.



Waiting time 2 (W2): After a pre-set waiting time of 60 min, the double jacket steam generator is no longer heated. Accordingly, the length of the program run time increases by approx. 5 min upon the next start, depending on the length of the operating pause, as the double jacket steam generator must first be pre-heated to the necessary start temperature.

Setup of the energy-saving mode is described here:

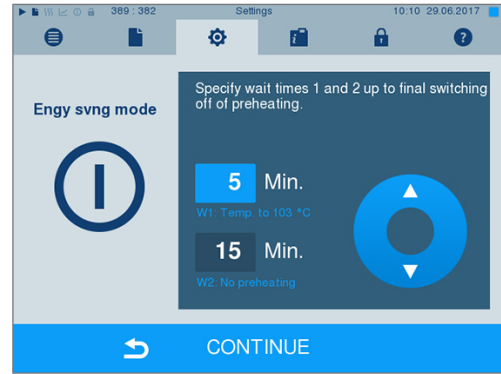
1. Select the **Settings > Energy saving mode** menu.



➔ The display switches to the settings window.

2. Select waiting time 1 directly by touching the minute. The area is displayed light blue.
3. Change the minutes using the  and  pushbuttons.
4. Repeat the steps for waiting time 2.
5. Press CONTINUE.

Switching off the display

Optionally, you can choose whether the display is to be switched off when the steam sterilizer is in energy-saving mode (waiting time 2).

1. Set the checkmark next to **Activated** and set the number of seconds after which the display is to be deactivated.

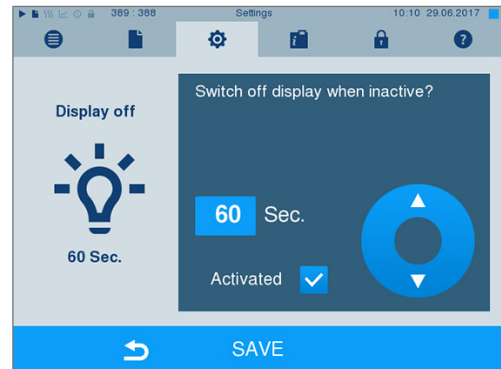

2. Confirm the settings with SAVE.

➔ The display switches automatically to the **Settings** menu.
3. You can switch the display back on by touching the screen.

11 Maintenance

Servicing intervals

Interval	Measure	Device components
Daily	Check for soiling, deposits or damage	Chamber inc. door seal and chamber sealing face, door lock, mount for the load
With every filling of the storage tank	Check the storage tank for soiling and clean it if necessary before filling	Internal storage tank
Every 2 weeks	Clean the left-hand chamber of the storage tank (waste water)	Internal storage tank
Every 2 months	Clean, check and oil the locking spindle and nut	Door mechanism
After 24 month or 2000 cycles	Maintenance	By the authorized customer services working in accordance with the maintenance instructions.
As required	Cleaning the surfaces	Housing parts

Cleaning



NOTICE

Inappropriately performed cleaning can lead to the scratching of and damage to surfaces and the development of leaks in sealing surfaces.

This also favours the development of soiling deposits and corrosion in the sterilization chamber.

- Comply with all information regarding cleaning of the part affected.
- Do not use any hard objects for cleaning such as a metal saucepan cleaner or a steel brush.

Sterilization chamber, chamber sealing face, mount, trays

To maintain the value of your device and to avoid persistent contamination and deposits, MELAG recommends weekly cleaning of the surfaces (e.g. with the MELAG chamber cleaning set).

Cleaning the sterilization chamber, chamber sealing face, mount and trays

The following must be fulfilled or present:

- ✓ *The device has been switched off and the power plug has been unplugged from the socket.*
- ✓ *The device has been completely cooled.*
- ✓ *Trays or sterilization containers and the associated mount have been removed from the sterilization chamber.*

1. Wet the surfaces to be cleaned completely with the cleaning fluid.
PLEASE NOTE: You should not allow cleaning fluid to enter the piping coming from the sterilization chamber.
2. Spread the cleaning fluid evenly with a non-fuzzing cloth.
3. Allow the cleaning fluid to act and evaporate for a sufficient time.
4. Using a new non-fuzzing cloth, spread ample amounts of demineralised water over the cleaned surfaces.

5. Wipe the surfaces thoroughly to remove cleaning residues. Repeat this process as necessary after wringing out the cloth.
 - ↳ Residues of cleaning fluids can ignite or cause deposits on the instruments.
6. Allow the cleaned areas to dry completely. This may take a few minutes.
7. Finally, wipe the cleaned surfaces with a dry, non-fuzzing microfibre cloth.
8. Clean the door seal with neutral liquid detergent.

Housing parts

Where necessary, clean the housing parts with a neutral fluid cleaner or spirit.

Internal storage tank

Should you use the internal storage tank for the feed water supply, perform regular checks and cleaning as follows:

Interval	
Upon every refill	Check the storage tank for soiling. If necessary, clean the storage tank with fresh feed water before filling.
Every 2 weeks	Clean the left-hand side chamber of the storage tank (wastewater).

Video tutorial

See also "Filling and emptying stand-alone autoclaves".



CAUTION

Hot wastewater in the storage tank and at the water drain tap.

This could result in burns

- Empty the storage tank before cleaning.
- Do not touch the water drain tap and parts connected to it with unprotected hands.

Empty the chamber of the internal storage tank

1. Open the service hatch in the lower area of the steam sterilizer.

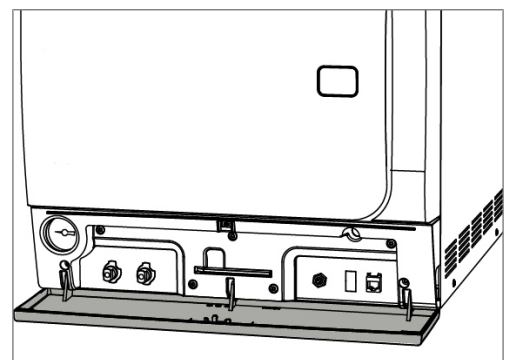

2. Place a min. 5 l bucket in front of the steam sterilizer.

3. Connect the drain hose onto one of the drain fittings on the waste water side (pos. a) or the feed water side (pos. b) until it snaps into place. The knob must be vertical.

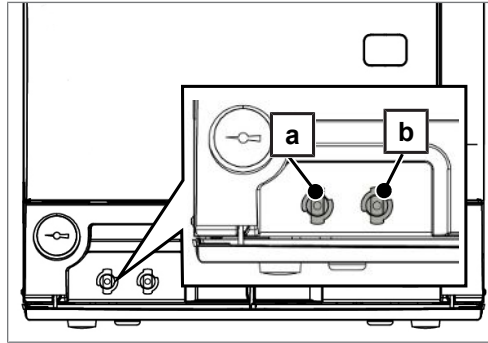

4. Open the water drain tap by turning the knob 1/4 in an anti-clockwise direction.

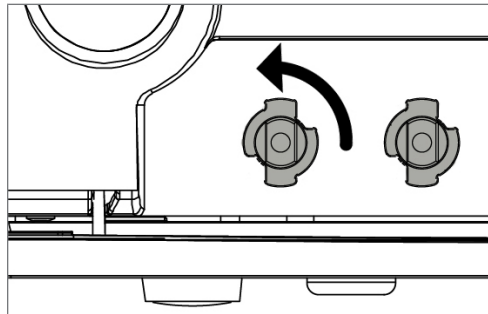

5. To remove the drain hose, turn the hose connection into the vertical position.

Cleaning the feed and waste water side

You can remove the cover of the storage tank completely to clean the chambers of the internal storage tank.

1. Remove the fore tank lid.
2. Grasp the cover on the filling opening and then lift the cover upwards a little.

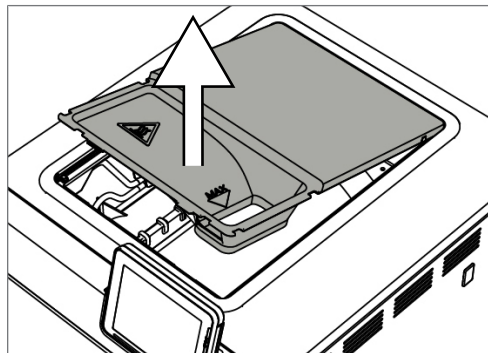

3. Remove the cover from the rubber seal completely.

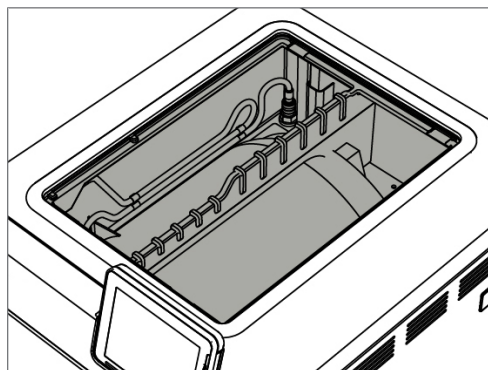

Avoiding staining

Only proper cleaning of the instruments prior to sterilization enables you to avoid residue from being released from the load under steam pressure during sterilization. Loosened dirt residue can clog the filter, fittings and valves of the device and deposit themselves on the instruments and in the sterilization chamber as deposits and stains.

All steam-conducting parts of the device consist of non-rusting material. This rules out the possibility of stain or rust development being caused by the steam sterilizer. Any rust which develops is always extraneous rust.

Incorrect instrument decontamination can result in the accretion of rust even on stainless steel instruments of leading manufacturers. Often, a single instrument which drops rust can suffice to cause the development of rust on other instruments or in the device. Remove foreign rust from the instruments using chlorine-free stainless steel cleaning fluid (see [Cleaning](#) ▶ page 65]) or send the damaged instruments to the manufacturer.

The extent of stain accretion on the instruments is also dependant on the feed water used for steam generation.

Checking and oiling the door lock



NOTICE

Wear of the door lock

Only use MELAG oil.

Check and oil the door lock every two months as follows:

1. Clean the locking spindle and nut with a non-fuzzing cloth.
2. Insert the test gauge into the door lock nut as far as it will go and turn it 180°. If this is not possible or resistance can be felt, the door lock nut is worn. Have the door lock nut replaced by an authorised technician.
3. Put two drops of oil in the door lock nut.

➔ The oil will be distributed automatically by closing the door.



Maintenance



NOTICE

Continuing operation beyond the maintenance interval can result in malfunctions in the device.

- Maintenance should only be performed by trained and authorised service technicians or stockist technicians.
- Maintain the specified servicing intervals.

Regular maintenance is vital to ensure reliable operation and value retention of the device. All function and safety-relevant components and electrical units must be checked during maintenance and replaced where necessary. Maintenance must be performed in accordance with the pertinent maintenance instructions of the device.

Maintenance work is to be performed regularly in accordance with the 2000 program cycles but must be performed after 24 months. The steam sterilizer will issue a maintenance message at the relevant time.

12 Pause times

Frequency of sterilization

Pause times between the individual programs are not necessary, as the sterilization chamber is maintained permanently at the same temperature. After the end/abort of the drying time and removal of the sterile material, you can load the steam sterilizer again and start a new program.

Duration of the operating pause

Duration of the operating pause	Measure
Short pauses between two sterilization processes	<ul style="list-style-type: none"> ▪ Keep the door closed to save energy ▪ Set the energy-saving mode correspondingly
Pauses which last longer than an hour	<ul style="list-style-type: none"> ▪ Switch off the steam sterilizer
Longer pauses e.g. over night or the weekend	<ul style="list-style-type: none"> ▪ Open the door and switch off the steam sterilizer ▪ Leave the door ajar to prevent premature wear and the sticking of the door seal ▪ If present, shut off the water inflow of the water treatment unit
Longer than two weeks	<ul style="list-style-type: none"> ▪ Perform a vacuum test ▪ After a successful vacuum test, perform an empty sterilization run in Quick-Program S

After pauses, perform the checks described in chapter [Function tests](#) [▶ page 44] depending on the length of pause.

Decommissioning

When decommissioning the device for a long pause (e.g. due to holiday), proceed as follows:

1. Empty the double jacket steam generator, see [Emptying the double jacket](#) [▶ page 69].
2. Switch off the steam sterilizer at the power switch.
3. Disconnect the power plug from the socket and if necessary, allow the device to cool.
4. Empty the internal storage tank via the drain hose.
5. Shut off if present, the water inflow of the water treatment unit.

Emptying the double jacket

You have the option of draining the water in the double jacket steam generator easily via program Drain. In order to do so, the steam sterilizer is heated once, building up pressure in the double jacket so that the water can be drained fully from the double jacket steam generator.

1. Switch on the steam sterilizer at the power switch.

- Working in menu **Programs & Tests** select program **Drain** and press **START**.



- Following notification **Draining successful** switch off the steam sterilizer, so that water is not fed into the double jacket.

Transport



CAUTION

Danger of injury from incorrect carrying.

Lifting and carrying too heavy a load can result in spinal injury. Failure to comply with these provisions can result in crushing.

- The device should always be carried by two people.
- Use the correct carrying straps to carry the device.

Transport within the practice

Comply with the following provisions during transport within a room or the practice:

- ▶ Decommission the steam sterilizer, see [Decommissioning](#) [▶ page 69].
- ▶ Disconnect the connection hoses connected on the rear of the device.
- ▶ Should you wish to leave the mounts and trays or cassettes in the chamber during transport, protect the surface of the round blank. To do so, place some foam or bubble wrap between the round blank and mount.
- ▶ Close the steam sterilizer door before moving it.

Transport over long-distance / dispatch



For transport over longer distances, during the danger of frost and / for despatch or during maintenance, an authorized person must prepare the steam sterilizer according to instructions and empty the double-jacket steam generator entirely.

Recommissioning after relocation

When recommissioning after a move, proceed as with the first commissioning; see the technical manual.

13 Malfunctions

Not all notifications on the display are malfunction messages. Warnings and malfunction messages are issued on the display with an event number. This number serves identification purposes.

	Nature of the display notification	Explanation
	Notification	A number of notifications are messages providing information. Messages are not malfunction messages or warnings. They support the operation of the steam sterilizer.
	Warning message	Warning messages are displayed when necessary. These contain instructions which apply to you, the operator. Warnings are not malfunction messages. They help to ensure malfunction-free operation and to recognize undesirable situations. Comply with these warnings early in order to avoid malfunctions.
	Malfunction messages	Malfunction messages are issued when it is not possible to ensure safe operation or safety of sterilization. These can appear on the display shortly after activating the steam sterilizer or during a program run. If a malfunction occurs during a program run, the program will be aborted.



WARNING

Danger of infection from early program abort

Aborting a program before the drying phase begins means that the load is unsterile. This endangers the health of your patients and practice team.

- Re-pack the load if necessary.
- Repeat the sterilization of the load.

Troubleshooting online

All messages with current descriptions can be found in the Troubleshooting portal on the MELAG website (<https://www.melag.com/en/service/troubleshooting>).



Before contacting the technical service

Ensure that you have complied with all instructions relating to a warning or malfunction message issued on the display of the device. The following table contains a summary of the most important events. Should you be unable to find the relevant event, or your efforts do not redress the problem, you can contact your stockist or the MELAG customer service. To enable us to give the best possible service, please have the serial number of your device, the malfunction number and a detailed description of the malfunction to hand.

Displaying messages in MELAconnect

You can arrange for the direct transfer the warning and malfunction messages to your mobile end device using the MELAconnect app. Proceed as follows:

1. Press the key  of the notification to display the QR code.
2. Open MELAconnect on your mobile end device and navigate to the troubleshooting menu.
3. Activate the QR code symbol on your mobile end device.
4. Scan the QR code from the display of your steam sterilizer.
 - ➔ The event and suggestions for the solution will be displayed on your mobile end device.

Alternatively, you can enter and search for the event number directly in MELAconnect.

Messages

Event	Possible causes	What you can do
248	Vacuum test was carried out despite residual moisture in the sterilization chamber or with a load	Repeat vacuum test, when steam sterilizer is cold and empty

Warning and error messages

Incident	Possible causes	What you can do
62	When using the internal storage tank: a) Insufficient feed water in the right-hand chamber of the internal storage tank. b) The float switch of the right-hand chamber of the internal storage tank (feed water) is stuck.	a) Check whether there is sufficient feed water in the right-hand chamber of the internal storage tank and refill with feed water if necessary. b) Check the float switch as follows: 1. Remove the tank lid from the storage tank. 2. Remove the filling funnel if present. 3. Move the float in the right-hand chamber of the storage tank (feed water side from below in the tank) up and down repeatedly to restore its free-movement.
	When using a MELAG water treatment unit: c) The feed water supply in the device has been set to INTERNAL .	When using a MELAG water treatment unit: to c) Set the feed water supply in the Settings menu to EXTERNAL (see Water supply [▶ page 57]).
63	Very poor feed water quality (conductivity $\geq 60 \mu\text{S/cm}$).	
	When using the internal storage tank: a) Water of insufficient quality e.g. tap water was used.	a) Empty and clean the right-hand chamber of the internal storage tank (feed water side) and fill it with water of the required quality (EN 13060, Appendix C).
	When using a MELAG water treatment unit: b) MELAdem 40: The mixed-bed resin cartridge is exhausted. c) MELAdem 47: The mixed-bed resin cartridge, the pre-filter or the activated coal filter is exhausted.	b) MELAdem 40: Replace the mixed-bed resin cartridge in accordance with the applicable operating manual. c) MELAdem 47: Replace the mixed-bed resin cartridge and if necessary, the pre-filter and activated carbon filter in accordance with the applicable operating manual. Empty the pressure tank (if possible until it is half full) and wait until it has been filled again. An empty pressure tank requires c. 1 h to fill. Please note: The notification may also continue to be shown after the filter has been changed until the water remaining in the storage tank has been consumed.
64	see event 63	
65	see event 63	
66	The feed water inflow line between the water treatment unit and the steam sterilizer has a leak. Air is also taken in.	When using a MELAG water treatment unit: Check whether the feed water inflow line to the steam sterilizer has any leaks and has been connected correctly.

Incident	Possible causes	What you can do
67	<p>Only when using a water treatment unit: The waste water cannot flow off. A rinse must be performed after a further 2 or 3 program runs.</p> <p>a) The outlet hose is kinked or installed sagging. b) The siphon or the building-side waste water line is blocked. c) The Quick-Program B and S are mainly used. These programs do not have automatic rinsing.</p>	<p>a) Check the installation of the outlet hose. This must be installed without kinking or sagging and at a constant decline. b) Check whether the building siphon is blocked. Please note: If multiple devices are operated simultaneously, we recommend the installation of an additional siphon. c) Start another program e.g. the Universal-Program, Gentle-Program or Prion-Program to perform the necessary rinsing.</p>
71	<p>When using the internal storage tank: a) Insufficient feed water in the right-hand chamber of the internal storage tank. b) The float switch of the right-hand chamber of the internal storage tank (feed water) is stuck.</p>	<p>When using the internal storage tank: a) Check the water level of the feed water in the right-hand chamber of the internal storage tank and refill with feed water if necessary. b) Check the float switch as follows: 1. Remove the tank lid from the storage tank. 2. Remove the filling funnel if present. 3. Move the float in the right-hand chamber of the storage tank (feed water side from below in the tank) up and down repeatedly to restore its free-movement.</p>
	<p>When using a MELAG water treatment unit: c) The water supply is set to INTERNAL despite external water supply.</p>	<p>When using a MELAG water treatment unit: c) Set the feed water supply in the Settings menu to EXTERNAL (see Water supply [▶ page 57]).</p>
72	<p>Poor feed water quality (conductivity $\geq 40 \mu\text{S/cm}$).</p>	
	<p>When using the internal storage tank: a) Water of insufficient quality e.g. tap water was used.</p>	<p>a) Empty and clean the right-hand chamber of the internal storage tank (feed water side) and fill it with water of the required quality (EN 13060, Appendix C).</p>
	<p>When using a MELAG water treatment unit: b) MELAdem 40: The mixed-bed resin cartridge is exhausted. c) MELAdem 47: The mixed-bed resin cartridge, the pre-filter or the activated coal filter is exhausted.</p>	<p>b) MELAdem 40: Replace the mixed-bed resin cartridge in accordance with the applicable operating manual. c) MELAdem 47: Replace the mixed-bed resin cartridge and if necessary, the pre-filter and activated carbon filter in accordance with the applicable operating manual. Empty the pressure tank (if possible until it is half full) and wait until it has been filled again. An empty pressure tank requires c. 1 hour to fill. Please note: The notification may also continue to be shown after the filter has been changed until the water remaining in the pressure tank has been consumed.</p>
73	see event 72	

Incident	Possible causes	What you can do
74	Poor feed water quality (conductivity $\geq 40 \mu\text{S/cm}$).	
	When using the internal storage tank: a) Insufficient feed water in the right-hand chamber of the internal storage tank. b) The float switch of the right-hand chamber of the internal storage tank (feed water) is stuck.	a) Check the water level of the feed water in the right-hand chamber of the internal storage tank and refill with feed water if necessary. b) Check the float switch as follows: 1. Remove the tank lid from the storage tank. 2. Remove the filling funnel if present. 3. Move the float in the right-hand chamber of the storage tank (feed water side from below in the tank) up and down repeatedly to restore its free-movement.
	When using a MELAG water treatment unit: c) The water supply is set to INTERNAL despite external water supply.	When using a MELAG water treatment unit: c) Set the feed water supply in the Settings menu to EXTERNAL (see Water supply [▶ page 57]).
75	When using the internal storage tank: a) Insufficient feed water in the right-hand chamber of the internal storage tank. b) The float switch of the right-hand chamber of the internal storage tank (feed water) is stuck.	a) Check the water level of the feed water in the right-hand chamber of the internal storage tank and refill with feed water if necessary. b) Check the float switch as follows: 1. Remove the tank lid from the storage tank. 2. Remove the filling funnel if present. 3. Move the float in the right-hand chamber of the storage tank (feed water side from below in the tank) up and down repeatedly to restore its free-movement.
	When using a MELAG water treatment unit: c) The water supply is set to INTERNAL despite external water supply.	When using a MELAG water treatment unit: c) Set the feed water supply in the Settings menu to EXTERNAL (see Water supply [▶ page 57]).
76	a) The Quick-Program B and S are mainly used. These programs do not do not have automatic rinsing.	a) Start another program e.g. the Universal-Program, Gentle-Program or Prion-Program to perform the necessary rinsing.
	With connection to the building waste water outflow: The waste water cannot flow off. A rinse must be performed after a further 2 or 3 program runs. b) The waste water hose is kinked or installed sagging. c) The siphon or the building-side waste water line is blocked.	With connection to the building waste water outflow: b) Check the installation of the waste water hose. This must be installed without kinking or sagging and at a constant decline. c) Check whether the building siphon is blocked. Please note: If multiple devices are operated simultaneously, we recommend the installation of an additional siphon.
78	a) The left-hand chamber of the internal storage tank (waste water) is full or was only incompletely emptied. b) If the notification is displayed despite an empty tank, the float switch is blocked.	a) Empty the left-hand chamber of the storage tank (waste water). b) Check the float switch as follows: 1. Remove the tank lid from the storage tank. 2. Remove the filling funnel if present. 3. Move the float in the left-hand chamber of the storage tank (feed water side from below in the tank) up and down repeatedly to restore its free-movement.
80	see event 78	

Incident	Possible causes	What you can do
81	<p>a) The door was not pushed closed for long enough with sufficient force; as a result, the thread has become caught.</p> <p>b) The door spindle and/or the door lock nut were not properly maintained.</p> <p>c) The door spindle and/or the door lock nut were not oiled regularly with the MELAG oil.</p>	<p>a) Close and hold the door with force for approx. 3 s until the spindle engages in the door lock and the door is pulled in automatically. A motor sound is audible.</p> <p>b) Check the door lock every two months (see Checking and oiling the door lock [▶ page 68]).</p> <p>c) Oil the door lock nut regularly with the MELAG oil (see Checking and oiling the door lock [▶ page 68]).</p> <p>Should this repeat, please contact the service technician.</p>
82	<p>a) There are objects in the door area. The door was blocked from outside during the opening process.</p> <p>b) A residual vacuum is present in the sterilization chamber. Pressure equalization has not been concluded.</p> <p>c) The door seal sticks to the seal face of the sterilization chamber.</p>	<p>a) Always keep the area in front of the door free so that it can open unhindered.</p> <p>b) 1. Wait two minutes and then confirm the notification with OK. 2. Should the door not open independently, switch off the steam sterilizer, wait five minutes and then switch it back on. Try again to open the door.</p> <p>If the door does not open, inform the authorized customer services/stockist technician.</p> <p>c) If it has proven possible to open the door (e. g. using the manual door emergency-opening, see Manual door emergency-opening [▶ page 21]) clean the door seal and the seal face on the sterilization chamber (see Cleaning [▶ page 65]).</p>
83	<p>The door does not reach a pressure-tight state after the program start.</p> <p>a) The door seal and/or the seal face is soiled and or damaged.</p> <p>b) The load blocks the door area.</p> <p>c) The closing mechanism is stiff.</p>	<p>a) Check the door seal and the seal face in the sterilization chamber for soiling, foreign bodies or damage.</p> <p>b) Check whether the load is blocking the door.</p> <p>c) Check the door spindle and the door lock nut for damage. Clean and oil the door spindle and the door lock nut with the oil included in the scope of delivery. Clean and oil the door spindle and the door lock nut with the oil included in the scope of delivery (see Checking and oiling the door lock [▶ page 68]).</p>
84	see event 82	
86	The door has not been closed correctly upon program start.	Close and hold the door with force for c. 3 seconds until the spindle engages in the door lock and the door is pulled in automatically. A motor sound is audible.
89	see event 86	

Incident	Possible causes	What you can do
102	a) The chamber filter "Pressure release" is blocked.	a) Remove the "Pressure release" chamber filter (in the rear area of the sterilization chamber below) and check whether it is e.g. soiled/blocked by packaging. If necessary, clean the chamber filter.
	With connection to the building waste water outflow: The waste water cannot flow off. b) The outlet hose is kinked or installed sagging. c) The siphon or the building-side waste water line is blocked.	With connection to the building waste water outflow: b) Check the installation of the outlet hose. This must be installed without kinking or sagging and at a constant decline. c) Check whether the building siphon is blocked. Please note: If multiple devices are operated simultaneously, we recommend the installation of an additional siphon.
103	The sterile filter is soiled/blocked.	1. Check whether the sterile filter suction aperture (centre aperture) on the rear panel of the steam sterilizer is blocked. If yes, replace the sterile filter. 2. If nothing can be recognized, remove the sterile filter on the rear panel of the steam sterilizer and perform a program run without a load. If the program has been ended successfully, the sterile filter is blocked. In this case, replace the sterile filter.
104	see event 103	
110	a) The steam sterilizer is overloaded or the load has been arranged badly. b) The mains voltage is too low, poor building voltage supply (e.g. undersized installation, defective socket, multiple devices on a single socket/fuse).	a) Comply with the maximum permissible load quantities (see Loading the steam sterilizer ▶ page 23]). Ensure that the load does not come into direct contact with or covers the steam injection nozzles. b) Check the building-side socket / test the steam sterilizer using a different socket or circuit.
111	see event 110	
113	a) The steam sterilizer was switched off at the power switch during a program run. b) The power plug has been disconnected or has not been connected correctly in the socket. c) Power outage in the building supply or the building-side RCD switch has tripped.	a) Never switch off the steam sterilizer at the power switch during a program run. b) Check whether the power plug is connected, the power cable has suffered damage or a loose contact or loose plug connections is the cause. Plug the power plug back into the mains socket. c) Arrange for an inspection of the building-side installation (e.g. automatic circuit breaker) and test the steam sterilizer at another socket or on another circuit.
114	see event 78	

Incident	Possible causes	What you can do
124	<p>a) The surrounding temperature of the steam sterilizer is too hot.</p> <p>b) The minimum clearance to the surrounding surfaces has not been maintained. The steam sterilizer receives no or insufficient cooling air.</p> <p>c) The steam sterilizer is overloaded.</p> <p>d) The steam sterilizer was operated without an insert rack and the load (especially the textiles) comes into direct contact with the chamber wall.</p> <p>e) The openings for suction of the cooling air on the underside of the steam sterilizer are covered.</p> <p>f) The chamber filter "Vacuum" is soiled/ blocked.</p>	<p>a) The ambient temperature must be below 40 °C. We recommend a maximum temperature of 25 °C.</p> <p>b) Maintain a minimum clearance to the surrounding surfaces (see information in the technical manual).</p> <p>c) Comply with the maximum permissible load quantities (see Selecting the program [▶ page 27]). If necessary, perform a vacuum test.</p> <p>d) Always operate the steam sterilizer with an insert rack and comply with the loading information (see Loading the steam sterilizer [▶ page 23]).</p> <p>e) Check whether the cooling air suction openings in the underside of the steam sterilizer are covered and remove any objects obscuring them e.g. paper or packaging.</p> <p>f) Remove the "Vacuum" chamber filter (in the rear area of the sterilization chamber below) and check whether it is e.g. soiled/ blocked by packaging. If necessary, clean the chamber filter.</p>
125	see event 124	
126	see event 124	
127	see event 124	
131	<p>a) The outlet hose is kinked or installed sagging.</p> <p>b) The siphon is blocked or the waste water line is impeded on the building side.</p> <p>c) Multiple devices have been connected to a single siphon and impeded each other during water discharge.</p> <p>d) The chamber filter "Pressure release" is blocked.</p>	<p>a) Check the installation of the outlet hose. This must be installed without kinking or sagging and at a constant decline.</p> <p>b) Check whether the building siphon or the waste water line is blocked.</p> <p>c) If multiple devices are operated simultaneously, we recommend the installation of an additional siphon.</p> <p>d) Remove the "Pressure release" chamber filter and check whether it is soiled/blocked by packaging. If necessary, clean the chamber filter.</p>
132	The steam sterilizer is overloaded or the load has been arranged badly.	Comply with the maximum permissible load quantities, see Loading the steam sterilizer [▶ page 23]. Ensure that the load does not come into direct contact with or covers the steam injection nozzles.
133	see event 124	
136	<p>a) The surrounding temperature of the steam sterilizer is too hot.</p> <p>b) The ventilation slots in the side walls are clogged/blocked.</p> <p>c) The steam sterilizer is installed. The minimum clearance to the surrounding surfaces has not been maintained.</p> <p>d) The door was left open after loading or unloading and hot steam has escaped from the sterilization chamber.</p>	<p>Switch off the steam sterilizer and allow it to cool for approx. 1 h.</p> <p>a) Comply with the requirements at the installation location and the maximum ambient temperature (see Technical Manual).</p> <p>b) Clean the ventilation slots and remove any objects covering them.</p> <p>c) Maintain a minimum clearance to the surrounding surfaces (see information in the Technical Manual).</p> <p>d) Always close the door after loading or unloading.</p>

Incident	Possible causes	What you can do
175	The overheat control switch of the main heating has tripped. This notification may be issued in alternation with E176: ACOUT 02 open.	<ol style="list-style-type: none"> 1. Switch off the steam sterilizer and press the reset button overheat control on the fore side of the steam sterilizer at the bottom right-hand side (behind the cover) back in. 2. Acknowledge the malfunction message. 3. Switch off the steam sterilizer and back on again and then perform an empty sterilization run if necessary. Then the steam sterilizer is ready for operation.
176	The overheat control switch of the main heating has tripped. This notification may be issued in alternation with E175: ACOUT 01 open.	<ol style="list-style-type: none"> 1. Switch off the steam sterilizer and press the reset button overheat control on the fore side of the steam sterilizer at the bottom right-hand side (behind the cover) back in. 2. Acknowledge the malfunction message. 3. Switch off the steam sterilizer and back on again and then perform an empty sterilization run if necessary. Then the steam sterilizer is ready for operation.
182	The mains voltage is too low, poor building voltage supply (e.g. undersized installation, defective socket, multiple devices on a single socket/fuse).	Arrange for an inspection of the building-side installation (e.g. automatic circuit breaker) and test the steam sterilizer at another socket or on another circuit.
183	see event 124	
185	see event 110	
186	see event 110	
187	<p>a) The chamber filter "Pressure release" is blocked.</p> <p>With connection to the building waste water outflow: The waste water cannot flow off.</p> <p>b) The waste water hose is kinked or installed sagging.</p> <p>c) The siphon or the building-side waste water line is blocked.</p>	<p>a) Remove the "Pressure release" chamber filter (in the rear area of the sterilization chamber below) and check whether it is e.g. soiled/blocked by packaging. If necessary, clean the chamber filter.</p> <p>With connection to the building waste water outflow: b) Check the installation of the waste water hose. This must be installed without kinking or sagging and at a constant decline.</p> <p>c) Check whether the building siphon is blocked. Please note: If multiple devices are operated simultaneously, we recommend the installation of an additional siphon.</p>
192	<p>When using the internal storage tank: a) The right-hand chamber of the internal storage tank (feed water) must be sufficiently filled with feed water for the pending rinsing process.</p> <p>When using a MELAG water treatment unit: b) The pending feed water procedure requires sufficient supply with feed water.</p>	<p>a) Check the water level of the feed water in the right-hand chamber of the internal storage tank and refill with feed water if necessary.</p> <p>b) Check whether the water inflow tap for the water treatment unit is open. When using a MELAdem 47, check whether the tap on the pressure tank is open.</p>
193	The left-hand chamber of the internal storage tank (waste water) must be empty for the pending rinsing process.	NOTICE! Danger of draining through the emergency overflow. Check the water level and empty the left-hand chamber of the internal storage tank (wastewater) completely.
203	No log output options have been set.	Check the configuration in the menu Settings > Logging .
204	The internal log memory is full.	Output the log saved in the steam sterilizer on any output medium or adapt the general output options in the Settings > Logging menu.

Incident	Possible causes	What you can do
207	see event 203	
208	see event 204	
211	see event 204	
214	The steam sterilizer has not recognized the CF card; it cannot be read, it is full or it is damaged.	<ol style="list-style-type: none"> 1. Check whether the CF card has been inserted correctly (do not insert under voltage). 2. Make sure that the CF card is not larger than 4 GB. 3. Check whether the write-protection has been set on the CF card by mistake. 4. Test the CF card on a computer. 5. Check whether the memory on the CF is full. If the memory is full, transfer the log files on the CF card to a computer and delete the files on the CF card. 6. Transfer the log files on the CF card to a computer and re-format the CF card in the steam sterilizer. 7. The CF card is defective or incompatible. It is possible that a non-MELAG CF card has been used. <p>Please note: We recommend using only original MELAG CF cards.</p>
218	The attempt was made to overwrite a write-protected log with a log of the same name.	<ol style="list-style-type: none"> 1. Transfer the log file the CF card to another computer and delete the file from the CF card. 2. Insert the empty CF card in the card slot and enter the log again.
221	The CF card or a sub-directory of the CF card is full.	<ol style="list-style-type: none"> 1. Transfer the present log files from the CF card to a computer. 2. Re-format the CF card in the steam sterilizer.
223	The CF card has not been recognized.	<ol style="list-style-type: none"> 1. Transfer the present log files from the CF card to a computer. 2. Format the CF card in the steam sterilizer. 3. Try again.
224	see event 223	
228	see event 223	
229	The CF card was removed from the slot during a writing/reading action.	Never remove the CF card from the slot whilst it is being written or read. Insert the CF card in the card slot and repeat the procedure.
231	The CF card cannot be located/has not been inserted.	Check whether the CF card has been inserted correctly or insert it in the slot again. Upon repeated incidence, transfer the present log files from the CF card to a computer and format the CF card in the steam sterilizer and then try again.
232	see event 229	
236	File malfunction on the CF card.	<ol style="list-style-type: none"> 1. Transfer the present log files from the CF card to a computer. 2. Format the CF card in the steam sterilizer. 3. Try again.
237	The CF card has not been recognized.	Check whether the CF card is write-protected and remove the write protection. Upon repeated incidence, transfer the present log files from the CF card to a computer and format the CF card in the steam sterilizer and then try again.

Incident	Possible causes	What you can do
238	<p>a) It is not possible to format the CF card because it is larger than 4 GB.</p> <p>b) The CF card is defective or incompatible.</p> <p>c) The CF card is write-protected.</p>	<p>a) Only use CF cards with max. memory size of 4 GB.</p> <p>b) 1. Attempt to format the CF card on the computer. 2. The CF card is defective or incompatible. It is possible that a non-MELAG CF card has been used. Please note: We recommend using only original MELAG CF cards.</p> <p>c) Disable the write-protection on the CF card.</p>
240	The CF card has not been recognized.	<p>Make sure that the CF card has been inserted in the slot correctly.</p> <p>Upon repeated incidence, transfer the present log files from the CF card to a computer and format the CF card in the steam sterilizer and then try again.</p>
249	The door does not close. The door seal and/or the seal face is soiled.	Check and clean the door seal and seal face on the sterilization chamber for soiling, foreign bodies or damage (see Cleaning [▶ page 65]).
305	The connection cable behind the display is loose or has a loose contact.	Remove the display from the bracket and check whether the connection cable has been connected to the display correctly and has not suffered damage.
351	The maximum operating interval or the number of batches since initial commissioning or the last maintenance have been reached. Maintenance is necessary.	Arrange for maintenance with an authorized customer services/stockist technician. You can continue to operate the steam sterilizer until the maintenance.
353	The steam sterilizer was switched off too early after alteration of the settings.	Always wait until the alterations in the steam sterilizer have been fully accepted before switching off the steam sterilizer. This is indicated in the display by changing into the previous menu or through the start screen.
367	The internal malfunction log memory is full.	Ensure that the selected output media are suitable for your instruments and are ready. Working in the Log output menu, output the non-outputted logs.
377	An attempt was made to output logs via the log printer but a log printer is not connected.	Check whether the log printer has been connected correctly. If you do not wish to output any logs in the log printer, deactivate the log printer as an output medium (see Logging [▶ page 46]).
380	see event 377	
386	The internal program log memory is almost full.	Ensure that the selected output media are suitable for your instruments and are ready. Working in the Log output menu, output the non-outputted logs at the next opportunity.
397	<p>a) The network cable has been disconnected or is damaged.</p> <p>b) The network cable is not compatible.</p> <p>c) The computer is not switched on.</p> <p>d) The network connection was not configured correctly.</p> <p>e) The documentation software on the computer was not started.</p>	<p>a) Check whether the network cable has been connected correctly or is damaged.</p> <p>b) Check whether a 1:1 network cable has been connected. A 1:1 network cable must be used for the direct connection between steam sterilizer and computer.</p> <p>c) Switch on the computer.</p> <p>d) Check the network settings (see Logging [▶ page 46]).</p> <p>e) Start the documentation software.</p>

Incident	Possible causes	What you can do
402	The door is blocked and cannot be closed. a) The door seal and/or the seal face is soiled and or damaged. b) The load blocks the door area. c) The closing mechanism is stiff.	a) Check the door seal and the seal face in the sterilization chamber for soiling, foreign bodies or damage. b) Check whether the load is blocking the door. c) Check the door spindle and the door lock nut for damage. Clean and oil the door spindle and the door lock nut with the oil included in the scope of delivery (see table below: Recommended protective distances Checking and oiling the door lock [▶ page 68]).
407	The door does not reach a pressure-tight state after the program start. a) The door seal and/or the seal face is soiled and or damaged. b) The load blocks the door area. c) The closing mechanism is stiff.	a) Check the door seal and the seal face in the sterilization chamber for soiling, foreign bodies or damage. b) Check whether the load is blocking the door. c) Check the door spindle and the door lock nut for damage. Clean and oil the door spindle and the door lock nut with the oil included in the scope of delivery (see table below: Recommended protective distances Checking and oiling the door lock [▶ page 68]).
414	see event 102	
416	see event 214	
417	see event 397	
428	see event 102	
434	Overheat on temperature sensor 2	1. Switch off the steam sterilizer and allow it to cool for 15 min. 2. Start it again. The steam sterilizer is now ready for operation. Should this repeat, please contact the service technician.
438	The steam sterilizer must be validated.	Arrange for validation of the steam sterilizer.
439	see event 187	
452	An attempt was made to perform actions on the display, although the log printer is still printing.	Please wait until the label printer has printed all the labels. Then the desired action can be performed.
457	The date or time was set incorrectly.	Check the date and time settings and correct if necessary (see Date and time [▶ page 58]).
458	a) The date or time was set incorrectly. b) The start time pre-selection timer has run down but the steam sterilizer was switched off at the time for which the start time was selected.	a) Check the date and time settings and correct if necessary (see Date and time [▶ page 58]). b) The steam sterilizer must be switched on at time for which the start time is selected.
464	An attempt was made to perform actions on the display, although the log printer is still printing.	Please wait until the log printer has finished printing the log(s). Then the desired action can be performed.
465	a) The connection to the label printer has been interrupted. b) The label printer has not been switched on.	a) Check whether the power cable is connected to the socket and the Ethernet cable of the label printer is correctly connected with the steam sterilizer. b) Switch on the label printer. The power LED must illuminate green.
479	see event 397	
486	see event 82	
488	see event 457	

Incident	Possible causes	What you can do
489	see event 136	
490	see event 136	
492	see event 136	
692	see event 132	
693	see event 132	
694	see event 132	

14 Technical data

Device type	Vacuklav 41 B+	Vacuklav 43 B+
Device dimensions (H x W x D)	56.5 x 46 x 58 cm	56.5 x 46 x 69 cm
Empty weight	60 kg	69 kg
Operating weight	81 kg	91 kg
Sterilization chamber		
Chamber diameter/depth	Ø 25 cm 35 cm	Ø 25 cm 45 cm
Chamber volume	18.4 l	23.8 l
Electrical connection		
Electricity supply	220-240 V, 50/60 Hz, 3400 W 220-240 V, 50/60 Hz, 2800 W*) max. voltage range 207-253 V	
Building fuses	16 A, RCD 30 mA at 3400 W min. 13 A, RCD 30 mA at 2800 W*)	
Length of the power cable	2 m	
Overvoltage category (in accordance with EN 61010-1)	Transient overvoltage up to the values of overvoltage category II	
Degree of air pollution (in accordance with EN 61010-1)	2	
Ambient conditions		
Noise emission	64 dB(A)	
Heat emission (with max. load)	1.7 kWh	
Ambient temperature	5-40 °C (ideal range 16-26 °C)	
Degree of protection (following IEC 60529)	IP20	
Relative humidity	max. 80 % at 31 °C, decreases in a linear fashion up to max. 50 % relative humidity at 40 °C	
Max. altitude	4000 m	
Installation location	interior of a building	
Feed water connection		
Water quality	EN 13060, Appendix C	
Min. flow pressure	1.5 bar at 3 l/min	
Min. static water pressure	2 bar	
Max. static water pressure	10 bar	
Max. water consumption	0.74 l	0.83 l
Wastewater connection		
Max. throughflow volume	1.5 l	1.5 l
Max. water temperature	98 °C	98 °C

*) see type plate

15 Accessories and spare parts

You can obtain the specified articles and an overview of further accessories from your stockist.

Category	Article	Art. no.	
		Chamber depth 35 cm	Chamber depth 45 cm
Mounts	Mount C "Plus" for 6 trays or 3 MELAstore Box 100	ME81370	ME81380
	Mount D "Plus" for 2 MELAstore Box 200 or 2 MELAstore Box 100 and 2 narrow trays	ME82640	ME82650
	Mount E "Plus" for 6 trays (standard) and 2 narrow trays.	ME82400	ME82700
	Mount F "Plus" for 3 MELAstore Box 100 and 2 narrow trays	ME82660	ME82670
Trays	Tray	ME00280	ME00230
	Tray, narrow	ME01320	ME01310
Sterilization container with a single-use paper filter in accordance with DIN EN 868-8	15K (18 x 12 x 4.5 cm)	ME01151	
	15M (35 x 12 x 4.5 cm)	ME01152	
	15G (35 x 12 x 8 cm)	ME01153	
	17K (20 x 14 x 5 cm)	ME01171	
	17M (41 x 14 x 5 cm)	---	ME01172
	17G (41 x 14 x 9 cm)	---	ME01173
	23M (42 x 16 x 6 cm)	---	ME01231
	23G (42 x 16 x 12 cm)	---	ME01232
	28M (32 x 16 x 6 cm)	ME01284	
	28G (32 x 16 x 12 cm)	ME01285	
MELAstore System	MELAstore Tray 50 (18 x 11.8 x 3 cm)	ME01180	
	MELAstore Tray 100 (27.5 x 17.6 x 3 cm)	ME01181	
	MELAstore Tray 200 (27.5 x 17.6 x 4.3 cm)	ME01182	
	MELAstore Box 100 (31.2 x 19 x 4.6 cm)	ME01191	
	MELAstore Box 200 (31.2 x 19 x 6.5 cm)	ME01192	
Test body system	MELAcontrol Helix consisting of a Helix test body and 250 indicator strips	ME01080	
	MELAcontrol Pro consisting of a Helix test body and 40 indicator strips	ME01075	
Water treatment	MELAdem 40 ion exchanger	ME01049	
	MELAdem 47 reverse osmosis unit	ME01047	
For the documentation	MELAflash CF card	ME01043	
	MELAflash card reader	ME01048	
	MELAprint 44 log printer	ME01144	
	Ethernet adapter for MELAprint 42/44	ME40295	
	MELAprint 60 label printer	ME01160	
	Network cable (cross-over), 2 m	ME15813	
	Network cable (cross-over), 5 m	ME15814	
	Network cable (cross-over), 10 m	ME15815	
Other	Water stop	ME01056	
	Surface-mounted siphon	ME37410	

Category	Article	Art. no.
Spare parts	Oil for door lock nut	ME27515
	Test gauge TR16 for door lock nut	ME27522
	Door seal	ME45160

Glossary

Air leakage

is a location through which air can pass in and out without this being desired. Verification of the leakage serves to prove that the volume of air ingress in the chamber during the vacuum phase does not exceed a value which would prevent steam penetration of the sterilizer load and that the air leakage does not cause the possible contamination of the sterilizer load during the drying phase.

AKI

AKI is the abbreviation for "Arbeitskreis Instrumentenaufbereitung"

Authorised technician

The term "authorised technician" refers to an employee of a customer service provider or stockist who has been trained and authorised by MELAG to perform maintenance and installation work on MELAG devices. Only they may carry out this work.

Batch

The batch is the composition of items which has been subject to the same reprocessing procedure.

Bowie & Dick test

Steam penetration test with a standard test package; described in EN 285; the test is recognized in the large-scale sterilization industry.

CF card

The CF card is a memory medium for digital data; Compact Flash is an official standard, i.e. these memory cards can be used in every device fitted with the corresponding slot. The CF card can be read by every device that supports the standard and where necessary, written on.

Competent personnel

Trained personnel in accordance with national specifications for the respective area of application (dentistry, medicine, podiatry, veterinary medicine, cosmetics, piercing, tattoo) with the following contents: knowledge of instruments, hygiene and microbiology, risk assessment and classification of medical devices and instrument reprocessing.

Condensate

Fluid (e.g. water) produced by the cooling of and resultant separation from the vaporous state.

Conductivity

is the ability of a conductive chemical substance or mixture of substances to conduct or transfer energy or other substances or particles in space.

Corrosion

The chemical alteration or destruction of metal materials by water and chemicals

Delay in boiling

This refers to the phenomenon that it is possible under certain circumstances to heat a fluid beyond its boiling point without them boiling. This represents an unstable state; even low-level agitation can produce a large bubble within the shortest period, which expands explosively.

Demineralised water

Water without the minerals usually found in normal spring or tap water; is produced through ion exchange of normal tap water. It is used here as feed water.

DGSV

Abb.: Deutsche Gesellschaft für Sterilgutverordnung (German Association for the Sterilized Equipment Ordinance). The DGSV training centres are specified in DIN 58946, part 6 as "Requirements of personnel".

DGUV Regulation 1

DGUV is the abbreviation for "Deutsche Gesetzliche Unfallversicherung" (German Statutory Accident Insurance). The regulation 1 governs the principles of prevention.

DIN 58946-7

Standard – sterilization - steam sterilizers - part 7: Building requirements and requirements placed on the operating agents and the operation of steam sterilizers in the health-care branch

DIN 58953

Standard – sterilization, sterile equipment supply

Distilled water

From the Latin aqua destillata; also referred to as aqua dest; water which to a great extent is free from salts, organic material and micro-organisms, is produced from normal tap water or pre-cleaned water through the process of distillation (evaporation and subsequent condensation). Distilled water is used, for example, as feed water for steam sterilizers.

Double jacket steam generator

Serves the quick generation of steam outside the sterilization chamber, surrounds the sterilization chamber

Dynamic pressure test of the sterilization chamber

Serves to prove that the rate of pressure variations during a sterilization cycle does not exceed a particular value which could result in the damage of the packaging material. [see also EN 13060]

Empty chamber test

Test run without a load, performed to assess the performance of a sterilizer without the influence of

a load; facilitating verification of the temperatures maintained in comparison to the temperatures set. [see EN 13060]

EN 13060

Standard – small steam sterilizers

EN 867-5

Standard – non-biological systems for use in sterilizers – part 5: The determination of indicator systems and test bodies for the performance inspection of type B and type S small sterilizers.

EN ISO 11140-1

Standard – the sterilization of products for use in medical treatment – chemical indicators – part 1: General requirements

EN ISO 11607-1

Standard - packaging for medical devices to be sterilized in the final packaging - Part 1: Requirements placed on materials, sterile barrier systems and packaging systems

Evacuation

Creation of a vacuum in a vessel

Feed water

Feed water is required to produce steam for sterilization. Guide values for water quality in accordance with EN 285 / EN 13060 – Appendix C

Fractionated vacuum procedure

A technical procedure in steam sterilization; the repeated evacuation of the sterilization chamber in alternation with steam injection.

FTP

Abbr.: (File Transfer Protocol) is a data transmission procedure serving to transport data from the internet. This data can include programs, files or even information. Special FTP programs (FTP clients) serve to load the data onto a server.

Heat-up phase

The time required after the steam sterilizer has been switched on / after the start of a sterilization program, to heat the double-jacket steam generator before the sterilization procedure starts. The duration is dependent on temperature at which sterilization takes place.

Load

Products, devices or materials that are reprocessed together in one operating cycle.

Mixed loads

wrapped and unwrapped load within a single batch

Multiple wrapping

e.g. wrapped instruments sealed in a double layer of film or wrapped in film and placed in an additional container or a container wrapped in textiles.

Network cable (crossover)

A crossover cable connects two computers (through network cards) directly without the use of a hub/switch. This type of connection corresponds with the network connection of the steam sterilizer in the practice network. The crossover cable does not run in parallel between the connectors, rather certain skimmers are crossed.

Porous

Pervious to liquids and air, e.g. textiles

Porous full load

Serves to prove that the values set on the control satisfy the necessary sterilization conditions in porous loads with a maximum mass for which the sterilizer is designed in accordance with EN 13060 [see also EN 13060].

Porous partial load

Serves to prove that the values set on the control allow steam to enter the pre-determined test package quickly and equally [see also EN 13060]

Process evaluation system

Also known as the self-monitoring system – this observes itself and compares the various sensors during a current program.

Product with narrow lumen

An article open on one side to which the following applies: $1 \leq L/D \leq 750$ and $L \leq 1500$ mm or an article with an opening on both sides which is: $2 \leq L/D \leq 1500$ and $L \leq 3000$ mm and which does not correspond to a hollow body article B; L...length of hollow body article; D...Diameter of hollow body article [see also EN 13060]

Qualified electrician

Person with suitable technical training, knowledge and experience so that he or she can recognise and avoid hazards that can be caused by electricity [see IEC 60050 or for Germany VDE 0105-100].

RKI

Abbreviation for "Robert Koch Institute". It is one of the most important bodies for the safeguarding of public health in Germany.

Simple hollow bodies

An article open on one side to which the following applies: $1 \leq L/D \leq 5$ and $D \geq 5$ mm or an article with an opening on both sides which is: $2 \leq L/D \leq 10$ and $D \geq 5$ L...hollow body article length D... hollow body article diameter [see EN 13060]

Single wrapping

Wrapped once e.g. instruments sealed in foil – in opposition to: Multiple wrapping

Soft sterilization packaging

e.g. a paper bag or transparent sterilization packaging

Solid

Without hollows or gaps, solid, compact, closed

Solid load

Serves to prove that the necessary sterilization conditions have been reached within the entire load with the values set in the control. The load must represent the largest weight of massive instruments designed for sterilization in a sterilizer in accordance with EN 13060. [see also EN 13060]

Sterile barrier system

A closed minimum packaging which prevents the entrance of micro-organisms e.g. through sealing bags, sealed and re-usable containers and folded sterilization towels etc.

Sterile material

Also referred to as a batch: a load which has already been sterilized, i.e. is sterile

Sterilization chamber

The interior of a sterilizer accommodates the load

TCP

Abbr.: Transmission control protocol: refers to a standard protocol for connecting computers and networks.

Vacuum

In common parlance, an area devoid of all material
In the technical sense: volumes with a reduced gas pressure (at least air pressure)

MELAG Medizintechnik GmbH & Co. KG

Geneststraße 6-10
10829 Berlin
Germany

Email: info@melag.com
Web: www.melag.com

Original instructions

Responsible for content: MELAG Medizintechnik GmbH & Co. KG
We reserve the right to technical alterations

Your stockist

